



The High Luminosity LHC programme: Science case, challenges and R&D

Nikos Konstantinidis

HEP Seminar, UCL, 21/02/2014



- What has LHC achieved so far?
- The LHC 20(+)-year plan – timelines and targets
- Science case for 3000fb^{-1} with HL-LHC
- LHC upgrades – how to deliver 3000fb^{-1}
- Detector upgrades for collecting efficiently 3000fb^{-1}
- Summary & Outlook



Arguably, the greatest discovery in fundamental science for half a century!

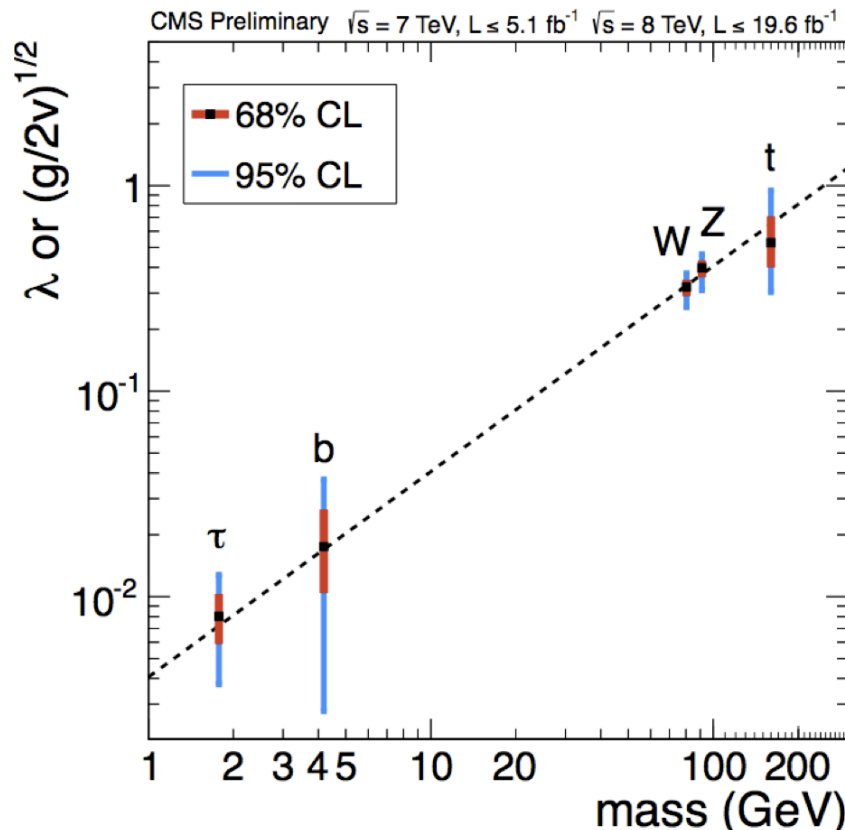

Showed that it couples to particles as the SM predicts (within current experimental accuracy)

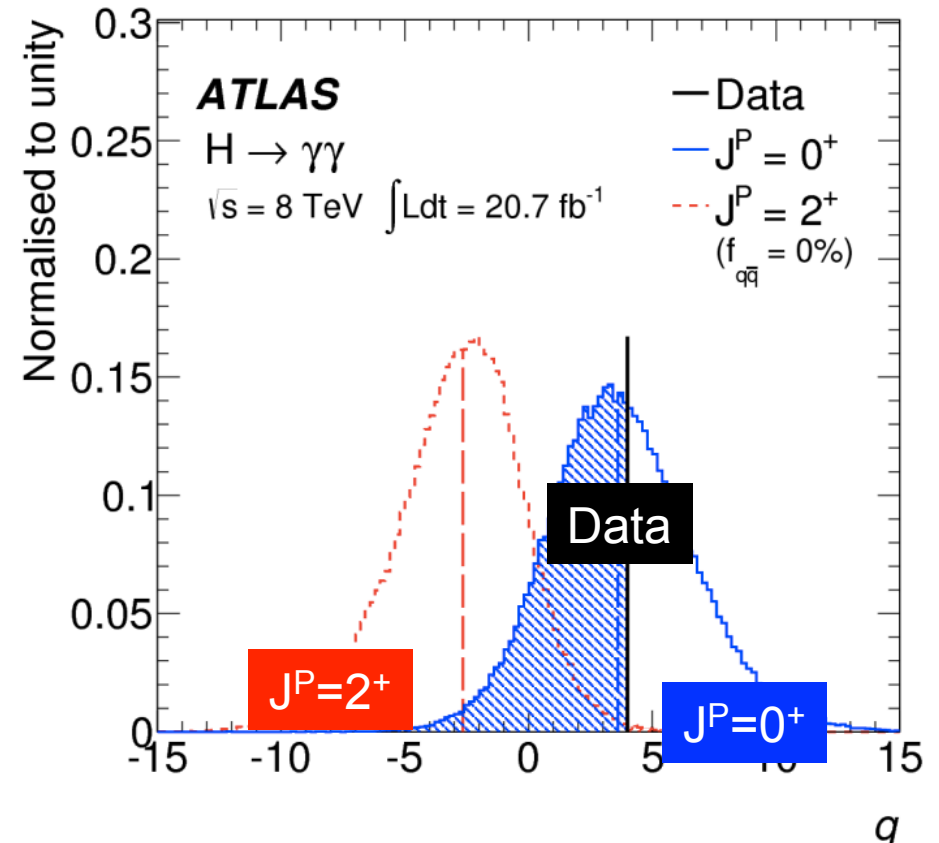

Proved that its spin-parity is $J^P=0^+$. Other values excluded at 97-99.XX% C.L.



- The first-ever fundamental scalar particle observed in nature
- The Higgs field played vital role in the evolution of the universe
 - Phase transition $\sim 10^{-11}$ sec after the Big Bang changed our universe:
 - From all massless particles => mostly massive particles

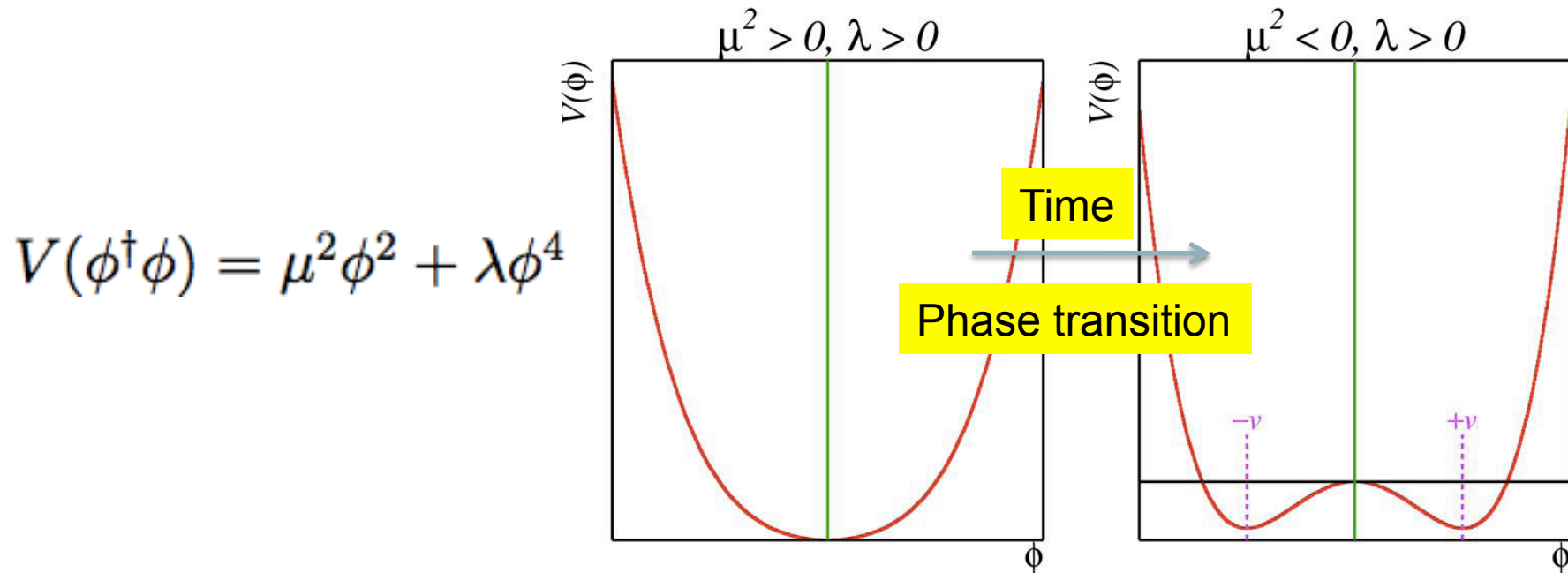

- How is this linked to the inflation theory?
 - According to cosmology, inflation was triggered by a scalar field
 - (E.g. see talk by Mikhail Shaposhnikov at [EPS 2013 in Stockholm](#))



- A wealth of measurements at 7-8 TeV, all in good agreement with the Standard Model predictions
- Rare processes observed for the first time (notably $B_s \rightarrow \mu\mu$ with $BR \sim 3 \times 10^{-9}$) and their rate agree well with the Standard Model expectations

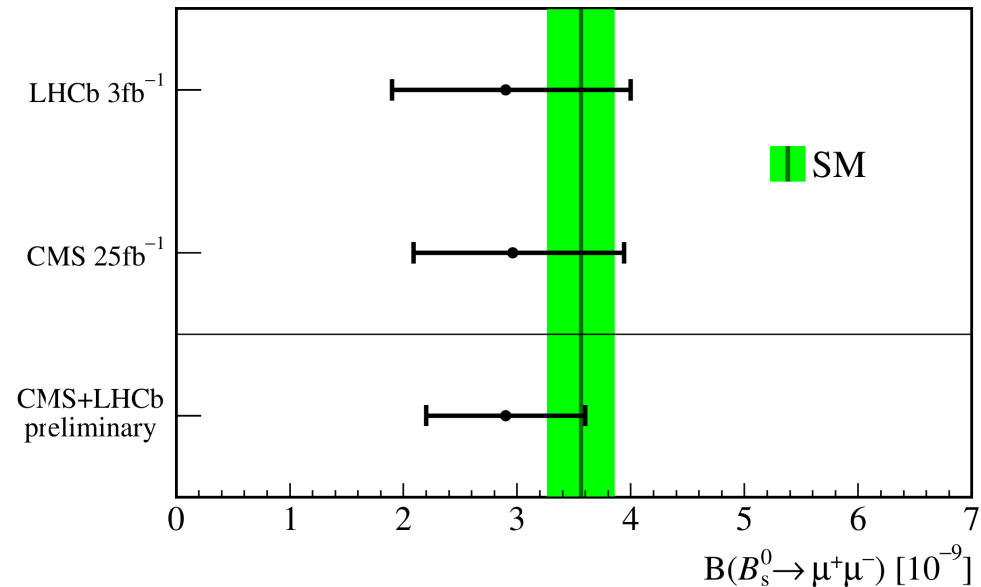
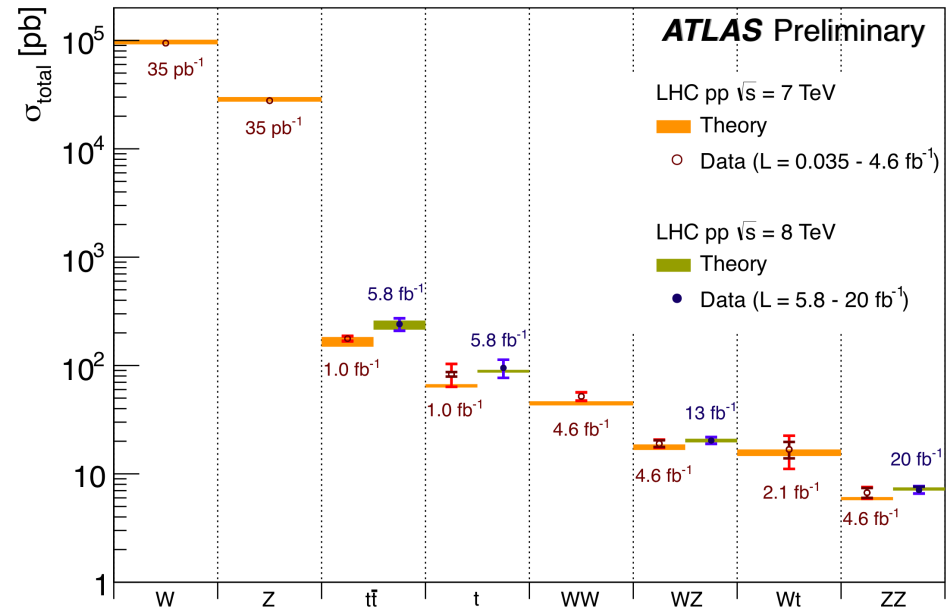



LHC result 3: No new physics!



ATLAS SUSY Searches* - 95% CL Lower Limits

Status: SUSY 2013

ATLAS Preliminary

$\int \mathcal{L} dt = (4.6 - 22.9) \text{ fb}^{-1}$ $\sqrt{s} = 7, 8 \text{ TeV}$

Model	e, μ, τ, γ	Jets	E_T^{miss}	$\int \mathcal{L} dt [\text{fb}^{-1}]$	Mass limit	Reference		
Inclusive Searches	MSUGRA/CMSSM	0	2-6 jets	Yes	20.3	\tilde{q}, \tilde{g} 1.7 TeV	$m(\tilde{q})=m(\tilde{g})$	ATLAS-CONF-2013-047
	MSUGRA/CMSSM	1 e, μ	3-6 jets	Yes	20.3	\tilde{g} 1.2 TeV	any $m(\tilde{q})$	ATLAS-CONF-2013-062
	MSUGRA/CMSSM	0	7-10 jets	Yes	20.3	\tilde{g} 1.1 TeV	any $m(\tilde{q})$	1308.1841
	$\tilde{q}\tilde{q}, \tilde{q} \rightarrow q\tilde{\chi}_1^0$	0	2-6 jets	Yes	20.3	\tilde{q} 740 GeV	$m(\tilde{\chi}_1^0)=0 \text{ GeV}$	ATLAS-CONF-2013-047
	$\tilde{g}\tilde{g}, \tilde{g} \rightarrow q\tilde{q}\tilde{\chi}_1^0$	0	2-6 jets	Yes	20.3	\tilde{g} 1.3 TeV	$m(\tilde{\chi}_1^0)=0 \text{ GeV}$	ATLAS-CONF-2013-047
	$\tilde{g}\tilde{g}, \tilde{g} \rightarrow q\tilde{q}\tilde{\chi}_1^0 \rightarrow q\tilde{q}W\tilde{\chi}_1^0$	1 e, μ	3-6 jets	Yes	20.3	\tilde{g} 1.18 TeV	$m(\tilde{\chi}_1^0) < 200 \text{ GeV}, m(\tilde{\chi}^\pm)=0.5(m(\tilde{\chi}_1^0)+m(\tilde{g}))$	ATLAS-CONF-2013-062
	$\tilde{g}\tilde{g}, \tilde{g} \rightarrow q\tilde{q}(\ell\ell/\ell\nu/\nu\nu)\tilde{\chi}_1^0$	2 e, μ	0-3 jets	-	20.3	\tilde{g} 1.12 TeV	$m(\tilde{\chi}_1^0)=0 \text{ GeV}$	ATLAS-CONF-2013-089
	GMSB ($\tilde{\ell}$ NLSP)	2 e, μ	2-4 jets	Yes	4.7	\tilde{g} 1.24 TeV	$\tan\beta < 15$	1208.4688
	GMSB ($\tilde{\ell}$ NLSP)	1-2 τ	0-2 jets	Yes	20.7	\tilde{g} 1.4 TeV	$\tan\beta > 18$	ATLAS-CONF-2013-026
	GGM (bino NLSP)	2 γ	-	Yes	4.8	\tilde{g} 1.07 TeV	$m(\tilde{\chi}_1^0) > 50 \text{ GeV}$	1209.0753
	GGM (wino NLSP)	1 $e, \mu + \gamma$	-	Yes	4.8	\tilde{g} 619 GeV	$m(\tilde{\chi}_1^0) > 50 \text{ GeV}$	ATLAS-CONF-2012-144
GGM (higgsino-bino NLSP)	γ	1 b	Yes	4.8	\tilde{g} 900 GeV	$m(\tilde{\chi}_1^0) > 220 \text{ GeV}$	1211.1167	
GGM (higgsino NLSP)	2 e, μ (Z)	0-3 jets	Yes	5.8	\tilde{g} 690 GeV	$m(H) > 200 \text{ GeV}$	ATLAS-CONF-2012-152	
Gravitino LSP	0	mono-jet	Yes	10.5	$F^{1/2}$ scale 645 GeV	$m(\tilde{g}) > 10^{-4} \text{ eV}$	ATLAS-CONF-2012-147	
3 rd gen. \tilde{g} med.	$\tilde{g} \rightarrow b\tilde{b}\tilde{\chi}_1^0$	0	3 b	Yes	20.1	\tilde{g} 1.2 TeV	$m(\tilde{\chi}_1^0) < 600 \text{ GeV}$	ATLAS-CONF-2013-061
	$\tilde{g} \rightarrow t\tilde{t}\tilde{\chi}_1^0$	0	7-10 jets	Yes	20.3	\tilde{g} 1.1 TeV	$m(\tilde{\chi}_1^0) < 350 \text{ GeV}$	1308.1841
	$\tilde{g} \rightarrow t\tilde{t}\tilde{\chi}_1^0$	0-1 e, μ	3 b	Yes	20.1	\tilde{g} 1.34 TeV	$m(\tilde{\chi}_1^0) < 400 \text{ GeV}$	ATLAS-CONF-2013-061
	$\tilde{g} \rightarrow b\tilde{t}\tilde{\chi}_1^0$	0-1 e, μ	3 b	Yes	20.1	\tilde{g} 1.3 TeV	$m(\tilde{\chi}_1^0) < 300 \text{ GeV}$	ATLAS-CONF-2013-061
3 rd gen. squarks direct production	$\tilde{b}_1\tilde{b}_1, \tilde{b}_1 \rightarrow b\tilde{\chi}_1^0$	0	2 b	Yes	20.1	\tilde{b}_1 100-620 GeV	$m(\tilde{\chi}_1^0) < 90 \text{ GeV}$	1308.2631
	$\tilde{b}_1\tilde{b}_1, \tilde{b}_1 \rightarrow t\tilde{\chi}_1^0$	2 e, μ (SS)	0-3 b	Yes	20.7	\tilde{b}_1 275-430 GeV	$m(\tilde{\chi}_1^0)=2m(\tilde{\chi}_1^\pm)$	ATLAS-CONF-2013-007
	$\tilde{t}_1\tilde{t}_1$ (light), $\tilde{t}_1 \rightarrow b\tilde{\chi}_1^\pm$	1-2 e, μ	1-2 b	Yes	4.7	\tilde{t}_1 110-167 GeV	$m(\tilde{\chi}_1^0)=55 \text{ GeV}$	1208.4305, 1209.2102
	$\tilde{t}_1\tilde{t}_1$ (light), $\tilde{t}_1 \rightarrow Wb\tilde{\chi}_1^\pm$	2 e, μ	0-2 jets	Yes	20.3	\tilde{t}_1 130-220 GeV	$m(\tilde{\chi}_1^0) = m(\tilde{t}_1) - m(W) - 50 \text{ GeV}, m(\tilde{t}_1) < m(\tilde{\chi}_1^\pm)$	ATLAS-CONF-2013-048
	$\tilde{t}_1\tilde{t}_1$ (medium), $\tilde{t}_1 \rightarrow t\tilde{\chi}_1^0$	2 e, μ	2 jets	Yes	20.3	\tilde{t}_1 225-525 GeV	$m(\tilde{\chi}_1^0)=0 \text{ GeV}$	ATLAS-CONF-2013-065
	$\tilde{t}_1\tilde{t}_1$ (medium), $\tilde{t}_1 \rightarrow b\tilde{\chi}_1^\pm$	0	2 b	Yes	20.1	\tilde{t}_1 150-580 GeV	$m(\tilde{\chi}_1^0) < 200 \text{ GeV}, m(\tilde{\chi}_1^\pm) - m(\tilde{\chi}_1^0) = 5 \text{ GeV}$	1308.2631
	$\tilde{t}_1\tilde{t}_1$ (heavy), $\tilde{t}_1 \rightarrow t\tilde{\chi}_1^0$	1 e, μ	1 b	Yes	20.7	\tilde{t}_1 200-610 GeV	$m(\tilde{\chi}_1^0)=0 \text{ GeV}$	ATLAS-CONF-2013-037
	$\tilde{t}_1\tilde{t}_1$ (heavy), $\tilde{t}_1 \rightarrow t\tilde{\chi}_1^0$	0	2 b	Yes	20.5	\tilde{t}_1 320-660 GeV	$m(\tilde{\chi}_1^0)=0 \text{ GeV}$	ATLAS-CONF-2013-024
	$\tilde{t}_1\tilde{t}_1, \tilde{t}_1 \rightarrow c\tilde{\chi}_1^0$	0	mono-jet/c-tag	Yes	20.3	\tilde{t}_1 90-200 GeV	$m(\tilde{t}_1) - m(\tilde{\chi}_1^0) < 85 \text{ GeV}$	ATLAS-CONF-2013-068
	$\tilde{t}_1\tilde{t}_1$ (natural GMSB)	2 e, μ (Z)	1 b	Yes	20.7	\tilde{t}_1 500 GeV	$m(\tilde{\chi}_1^0) > 150 \text{ GeV}$	ATLAS-CONF-2013-025
	$\tilde{b}_2\tilde{b}_2, \tilde{b}_2 \rightarrow \tilde{t}_1 + Z$	3 e, μ (Z)	1 b	Yes	20.7	\tilde{b}_2 271-520 GeV	$m(\tilde{t}_1) = m(\tilde{\chi}_1^0) + 180 \text{ GeV}$	ATLAS-CONF-2013-025
EW direct	$\tilde{\ell}_L\tilde{\ell}_L, \tilde{\ell}_L \rightarrow \ell\tilde{\chi}_1^0$	2 e, μ	0	Yes	20.3	$\tilde{\ell}$ 85-315 GeV	$m(\tilde{\chi}_1^0)=0 \text{ GeV}$	ATLAS-CONF-2013-049
	$\tilde{\chi}_1^\pm\tilde{\chi}_1^\pm, \tilde{\chi}_1^\pm \rightarrow \tilde{\ell}\nu(\tilde{\ell}\bar{\nu})$	2 e, μ	0	Yes	20.3	$\tilde{\chi}_1^\pm$ 125-450 GeV	$m(\tilde{\chi}_1^0)=0 \text{ GeV}, m(\tilde{\ell}, \bar{\nu})=0.5(m(\tilde{\chi}_1^\pm)+m(\tilde{\chi}_1^0))$	ATLAS-CONF-2013-049
	$\tilde{\chi}_1^\pm\tilde{\chi}_1^\pm, \tilde{\chi}_1^\pm \rightarrow \tilde{\tau}\nu(\tilde{\tau}\bar{\nu})$	2 τ	-	Yes	20.7	$\tilde{\chi}_1^\pm$ 180-330 GeV	$m(\tilde{\chi}_1^0)=0 \text{ GeV}, m(\tilde{\tau}, \bar{\nu})=0.5(m(\tilde{\chi}_1^\pm)+m(\tilde{\chi}_1^0))$	ATLAS-CONF-2013-028
	$\tilde{\chi}_1^\pm\tilde{\chi}_2^0 \rightarrow \tilde{\ell}_L\nu\tilde{\ell}_L(\tilde{\ell}\bar{\nu}), \tilde{\ell}\tilde{\nu}\tilde{\ell}_L(\tilde{\ell}\bar{\nu}\nu)$	3 e, μ	0	Yes	20.7	$\tilde{\chi}_1^\pm, \tilde{\chi}_2^0$ 600 GeV	$m(\tilde{\chi}_1^0)=m(\tilde{\chi}_2^0), m(\tilde{\chi}_1^0)=0, m(\tilde{\ell}, \bar{\nu})=0.5(m(\tilde{\chi}_1^\pm)+m(\tilde{\chi}_1^0))$	ATLAS-CONF-2013-035
	$\tilde{\chi}_1^\pm\tilde{\chi}_2^0 \rightarrow W\tilde{\chi}_1^0 Z\tilde{\chi}_1^0$	3 e, μ	0	Yes	20.7	$\tilde{\chi}_1^\pm, \tilde{\chi}_2^0$ 315 GeV	$m(\tilde{\chi}_1^0)=m(\tilde{\chi}_2^0), m(\tilde{\chi}_1^0)=0, \text{ sleptons decoupled}$	ATLAS-CONF-2013-035
	$\tilde{\chi}_1^\pm\tilde{\chi}_2^0 \rightarrow W\tilde{\chi}_1^0 h\tilde{\chi}_1^0$	1 e, μ	2 b	Yes	20.3	$\tilde{\chi}_1^\pm, \tilde{\chi}_2^0$ 285 GeV	$m(\tilde{\chi}_1^0)=m(\tilde{\chi}_2^0), m(\tilde{\chi}_1^0)=0, \text{ sleptons decoupled}$	ATLAS-CONF-2013-093
Long-lived particles	Direct $\tilde{\chi}_1^\pm\tilde{\chi}_1^\pm$ prod., long-lived $\tilde{\chi}_1^\pm$	Disapp. trk	1 jet	Yes	20.3	$\tilde{\chi}_1^\pm$ 270 GeV	$m(\tilde{\chi}_1^\pm) - m(\tilde{\chi}_1^0) = 160 \text{ MeV}, \tau(\tilde{\chi}_1^\pm) = 0.2 \text{ ns}$	ATLAS-CONF-2013-069
	Stable, stopped \tilde{g} R-hadron	0	1-5 jets	Yes	22.9	\tilde{g} 832 GeV	$m(\tilde{\chi}_1^0)=100 \text{ GeV}, 10 \mu\text{s} < \tau(\tilde{g}) < 1000 \text{ s}$	ATLAS-CONF-2013-057
	GMSB, stable $\tilde{\tau}, \tilde{\chi}_1^0 \rightarrow \tilde{\tau}(\tilde{e}, \tilde{\mu}) + \tau(e, \mu)$	1-2 μ	-	-	15.9	$\tilde{\chi}_1^0$ 475 GeV	$10 < \tan\beta < 50$	ATLAS-CONF-2013-058
	GMSB, $\tilde{\chi}_1^0 \rightarrow \gamma G$, long-lived $\tilde{\chi}_1^0$	2 γ	-	Yes	4.7	$\tilde{\chi}_1^0$ 230 GeV	$0.4 < \tau(\tilde{\chi}_1^0) < 2 \text{ ns}$	1304.6310
$\tilde{q}\tilde{q}, \tilde{\chi}_1^0 \rightarrow q\tilde{q}\mu$ (RPV)	1 μ , displ. vtx	-	-	20.3	\tilde{q} 1.0 TeV	$1.5 < c\tau < 156 \text{ mm}, \text{BR}(\mu)=1, m(\tilde{\chi}_1^0)=108 \text{ GeV}$	ATLAS-CONF-2013-092	
RPV	LFV $pp \rightarrow \tilde{\nu}_\tau + X, \tilde{\nu}_\tau \rightarrow e + \mu$	2 e, μ	-	-	4.6	$\tilde{\nu}_\tau$ 1.61 TeV	$\lambda'_{311}=0.10, \lambda_{132}=0.05$	1212.1272
	LFV $pp \rightarrow \tilde{\nu}_\tau + X, \tilde{\nu}_\tau \rightarrow e(\mu) + \tau$	1 $e, \mu + \tau$	-	-	4.6	$\tilde{\nu}_\tau$ 1.1 TeV	$\lambda'_{311}=0.10, \lambda_{1(2)33}=0.05$	1212.1272
	Bilinear RPV CMSSM	1 e, μ	7 jets	Yes	4.7	\tilde{q}, \tilde{g} 1.2 TeV	$m(\tilde{q})=m(\tilde{g}), c\tau_{\text{LSP}} < 1 \text{ mm}$	ATLAS-CONF-2012-140
	$\tilde{\chi}_1^\pm\tilde{\chi}_1^\pm, \tilde{\chi}_1^\pm \rightarrow W\tilde{\chi}_1^0, \tilde{\chi}_1^\pm \rightarrow ee\tilde{\nu}_\mu, e\mu\tilde{\nu}_e$	4 e, μ	-	Yes	20.7	$\tilde{\chi}_1^\pm$ 760 GeV	$m(\tilde{\chi}_1^0) > 300 \text{ GeV}, \lambda_{121} > 0$	ATLAS-CONF-2013-036
	$\tilde{\chi}_1^\pm\tilde{\chi}_1^\pm, \tilde{\chi}_1^\pm \rightarrow W\tilde{\chi}_1^0, \tilde{\chi}_1^\pm \rightarrow \tau\tau\tilde{\nu}_e, e\tau\tilde{\nu}_\tau$	3 $e, \mu + \tau$	-	Yes	20.7	$\tilde{\chi}_1^\pm$ 350 GeV	$m(\tilde{\chi}_1^0) > 80 \text{ GeV}, \lambda_{133} > 0$	ATLAS-CONF-2013-036
	$\tilde{g} \rightarrow qq\tilde{q}$	0	6-7 jets	-	20.3	\tilde{g} 916 GeV	$\text{BR}(t)=\text{BR}(b)=\text{BR}(c)=0\%$	ATLAS-CONF-2013-091
$\tilde{g} \rightarrow \tilde{t}_1 t, \tilde{t}_1 \rightarrow bs$	2 e, μ (SS)	0-3 b	Yes	20.7	\tilde{g} 880 GeV	-	ATLAS-CONF-2013-007	
Other	Scalar gluon pair, $sgluon \rightarrow q\tilde{q}$	0	4 jets	-	4.6	sgluon 100-287 GeV	incl. limit from 1110.2693	1210.4826
	Scalar gluon pair, $sgluon \rightarrow t\tilde{t}$	2 e, μ (SS)	1 b	Yes	14.3	sgluon 800 GeV	-	ATLAS-CONF-2013-051
	WIMP interaction (D5, Dirac χ)	0	mono-jet	Yes	10.5	M^* scale 704 GeV	$m(\chi) < 80 \text{ GeV}, \text{limit of } 687 \text{ GeV for D8}$	ATLAS-CONF-2012-147

$\sqrt{s} = 7 \text{ TeV}$ full data
 $\sqrt{s} = 8 \text{ TeV}$ partial data
 $\sqrt{s} = 8 \text{ TeV}$ full data

10⁻¹

1

Mass scale [TeV]



LHC result 3: No new physics!



ATLAS Exotics Searches* - 95% CL Lower Limits (Status: May 2013)

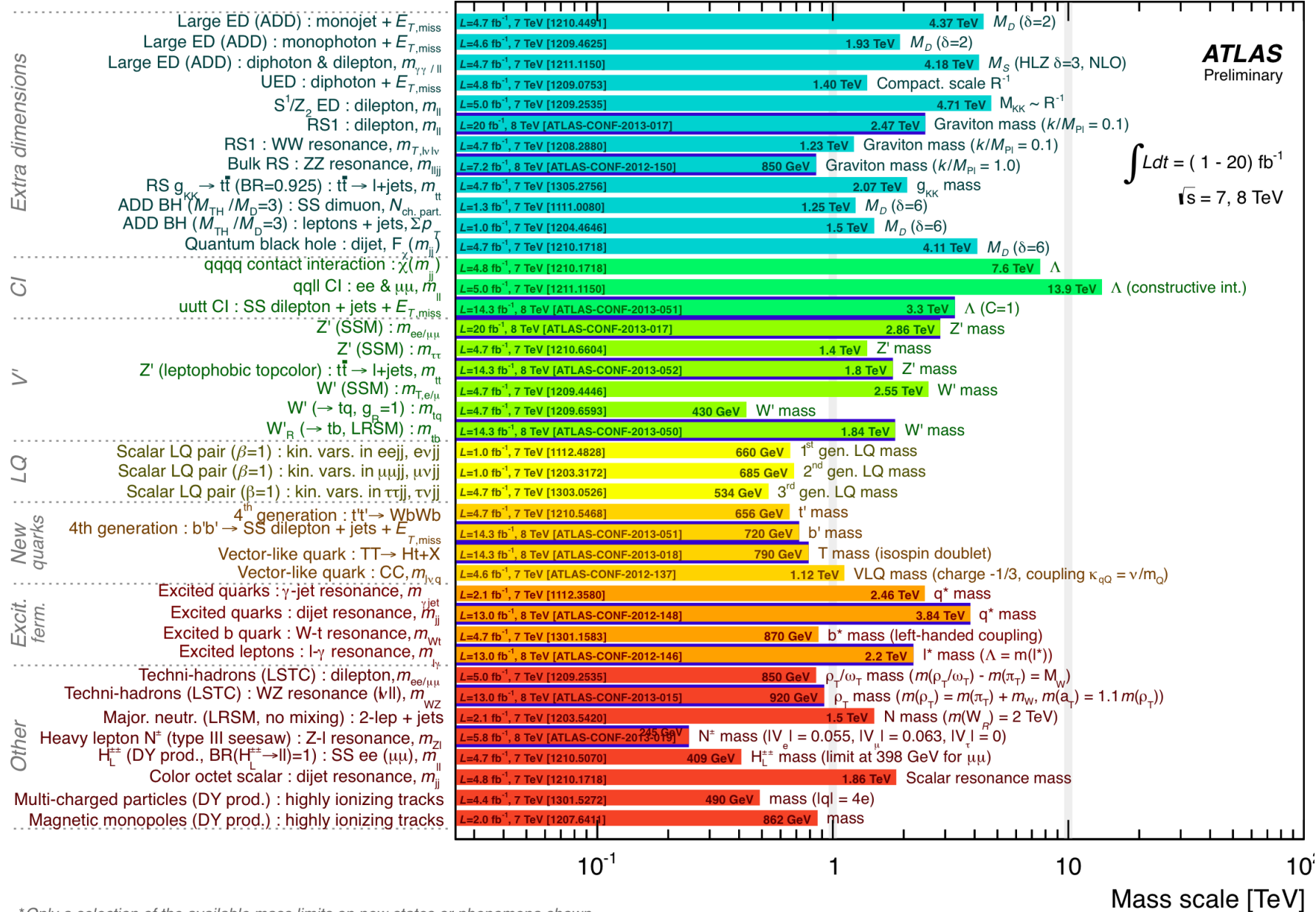

* Only a selection of the available mass limits on new states or phenomena shown



We have just started the exploration of the TeV scale!!!

Example: TeV-scale $X \rightarrow hh \rightarrow (bb)(bb)$
(X could be heavy Higgs, Graviton etc)

Sensitivity to σ -sections of a few fb!

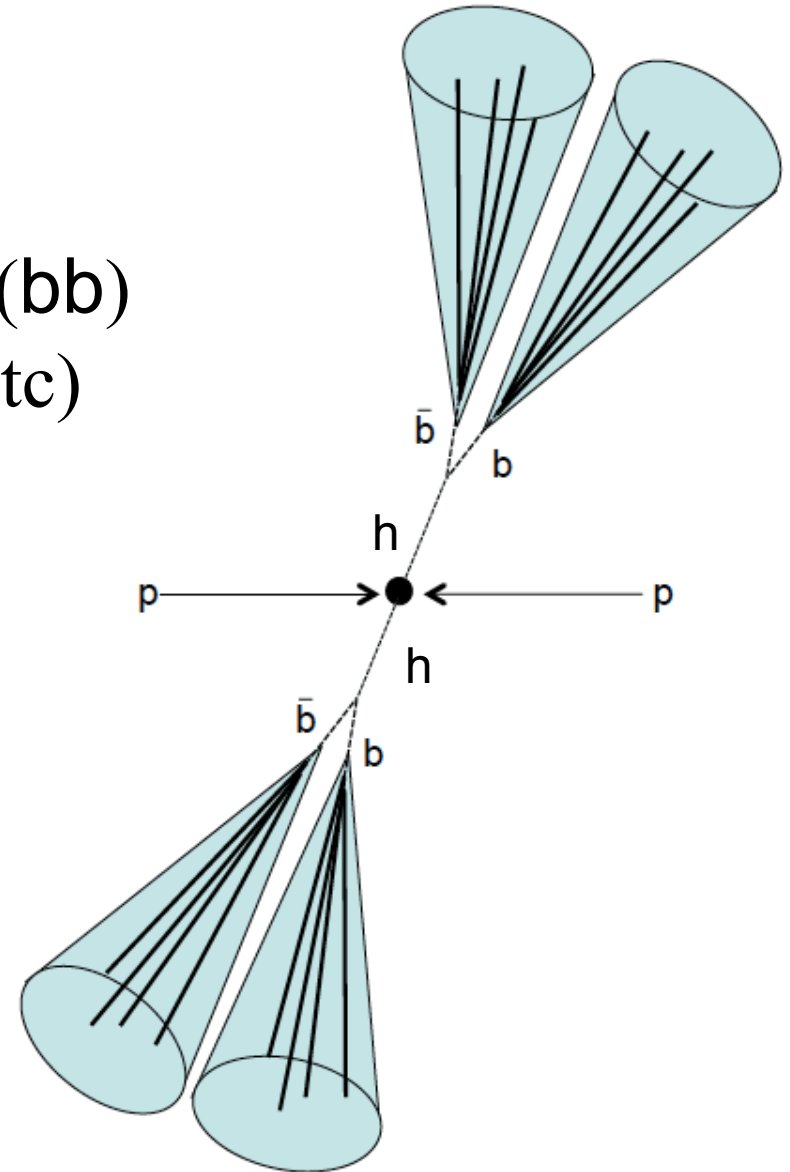
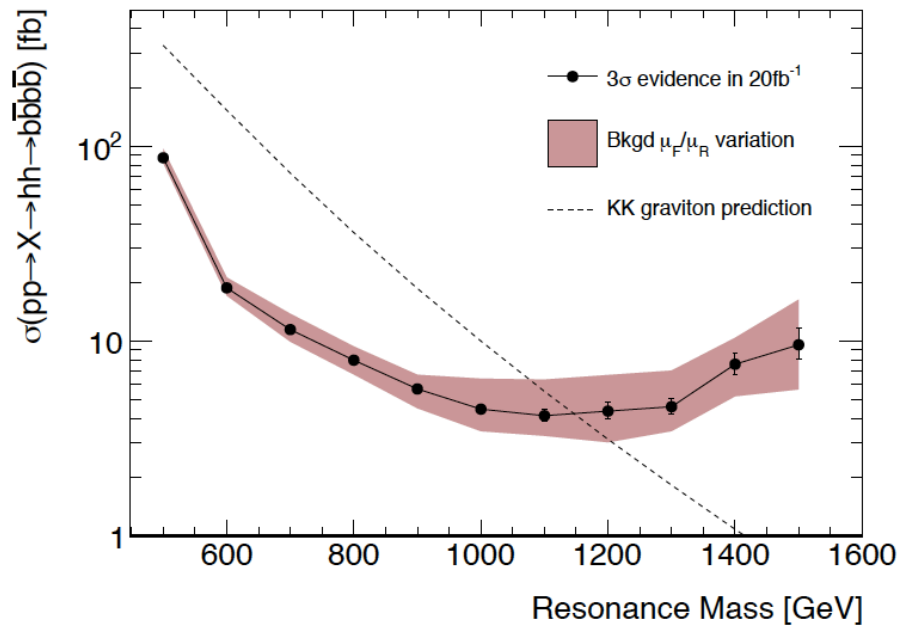

Phys. Rev. D 88, 114005 (2013) (Cooper, Konstantinidis, Lambourne, Wardrope)



- The Standard Model has come out triumphant at 7-8TeV!
- No sign of BSM physics => New Physics is heavy or less abundantly produced than what we could detect so far
- Despite the Higgs discovery, fundamental questions remain
 - How come the Higgs is so light (“naturalness” or “hierarchy” problem)?
 - What is Dark Matter and Dark Energy (the ~96% of our universe!)?
 - Why is Gravity so weak? Extra dimensions?
 - What’s the reason for the matter-antimatter asymmetry in our universe?



- Investigate thoroughly the mass generation mechanism
 - Measure the Higgs properties as accurately as possible
 - Are there heavier partners of the 125GeV Higgs boson?
 - Does Higgs moderate the vector boson scattering cross section @~1TeV?
- Explore the multi-TeV (and sub-TeV!) region as thoroughly as possible
 - Go to as high masses and as low cross sections as possible
- Search for/observe rare processes that would signal deviations from the Standard Model
 - E.g. flavour changing neutral currents in top decays, or rare B decays



- Investigate thoroughly the mass generation mechanism
 - Measure the Higgs properties as accurately as possible
 - Are there heavier partners of the 125GeV Higgs boson?
 - Does Higgs moderate the vector boson scattering @~1TeV?
- Explore the multi-TeV (and beyond) energy frontier as
 - Go to as high as possible
 - Run as long as possible
- Search for new processes that would signal deviations from the Standard Model
 - Look for flavour changing neutral currents in top decays, or rare B decays

The High Luminosity LHC is the only programme for the next 20 years that can have a good shot in all these fronts

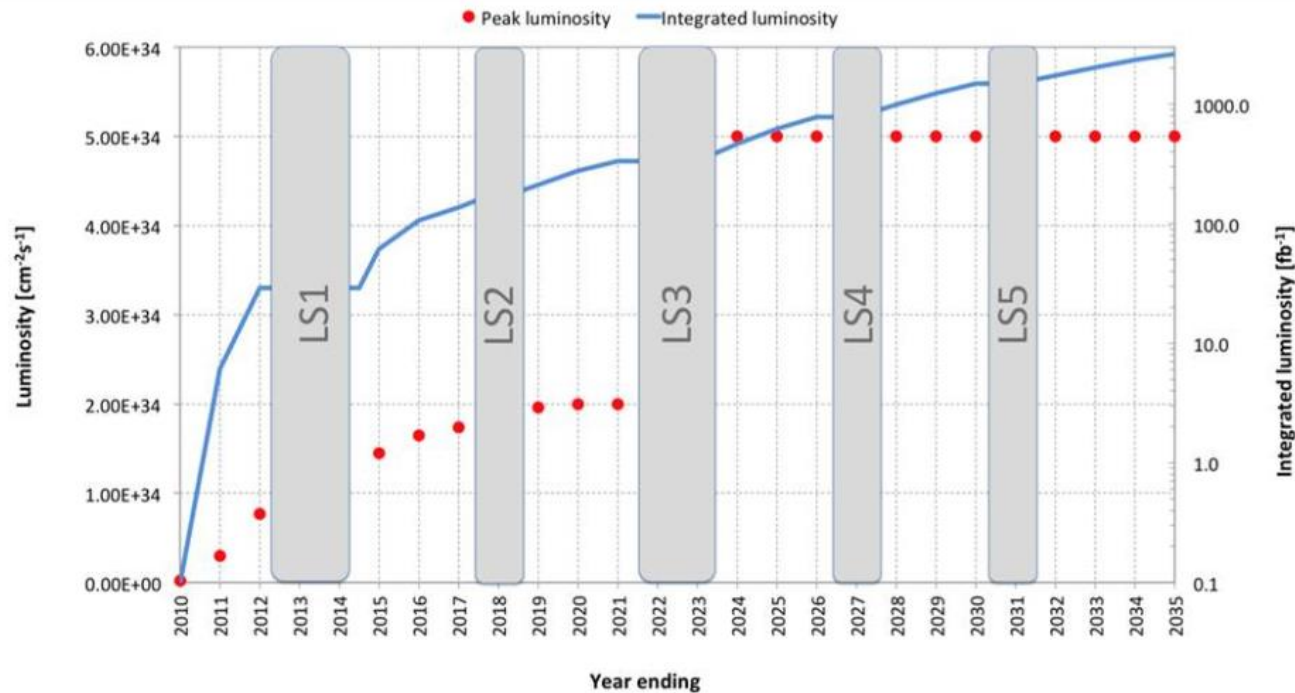

Next ~10 years:
Peak lumi: $\sim 2\text{e}34\text{cm}^{-2}\text{s}^{-1}$
 $\text{O}(30\text{fb}^{-1}) \rightarrow \text{O}(300\text{fb}^{-1})$
Programme approved

- HL-LHC programme:
 - Start in 2024 after a ~ 30 -month shutdown (LS3)
 - Peak luminosity: $\sim 5\text{e}34\text{cm}^{-2}\text{s}^{-1}$
 - ~ 140 pp collisions bunch crossing
 - Collect $\sim 250\text{-}300\text{fb}^{-1}/\text{year}/\text{expt}$ for a total of $\sim 3000\text{fb}^{-1}$ by the mid-2030s



- At the LHC, only possible to measure $\sigma \times \text{BR}$'s
 - Expressed as ratio to the SM values: $\mu = (\sigma \times \text{BR}) / (\sigma \times \text{BR})_{\text{SM}}$
- Ratios of partial widths can be derived without any model assumptions
- Interpretation in terms of couplings is model dependent
 - Expressed in terms of scale factors, κ , wrt SM values; $\Gamma_X / \Gamma_Y \sim (\kappa_X / \kappa_Y)^2$

Production

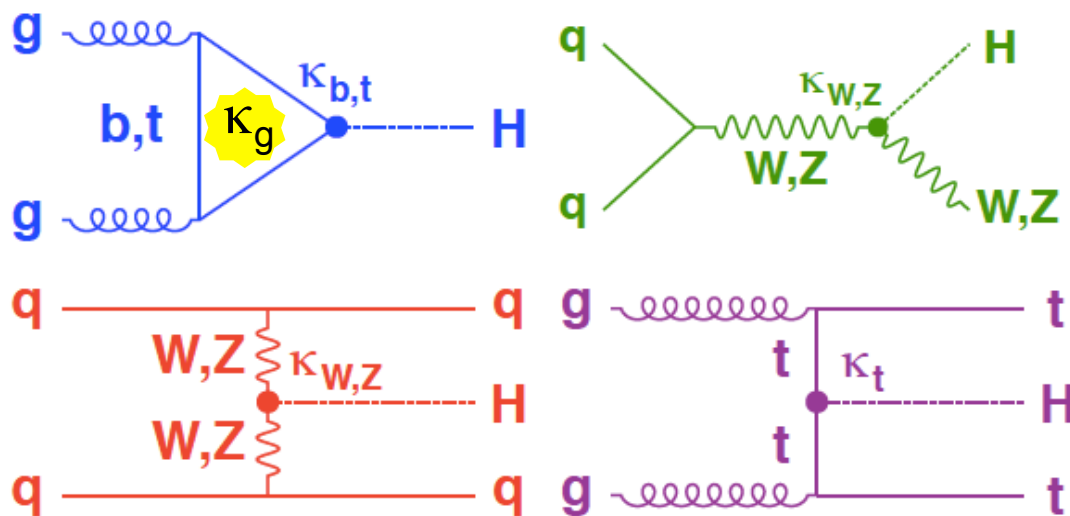

Decay

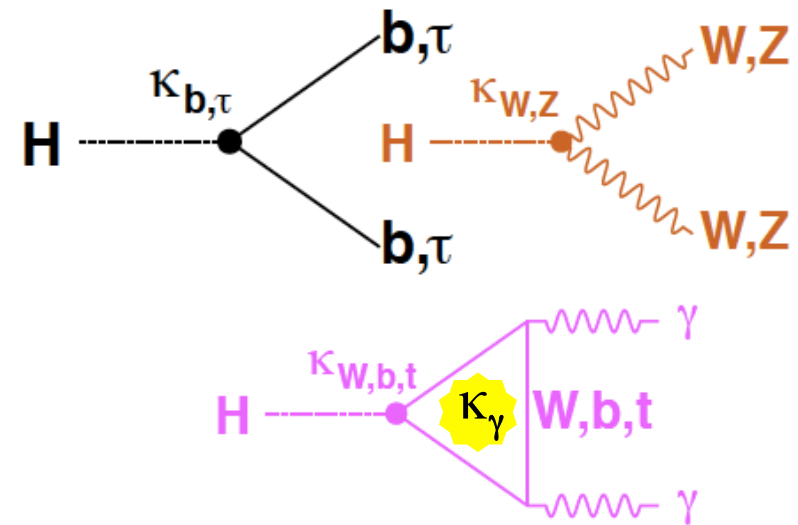



Will produce more than 100M Higgs bosons!
(including over a million non-hadronic decays)
Current results with ~ 1500 Higgs events (ATLAS+CMS)

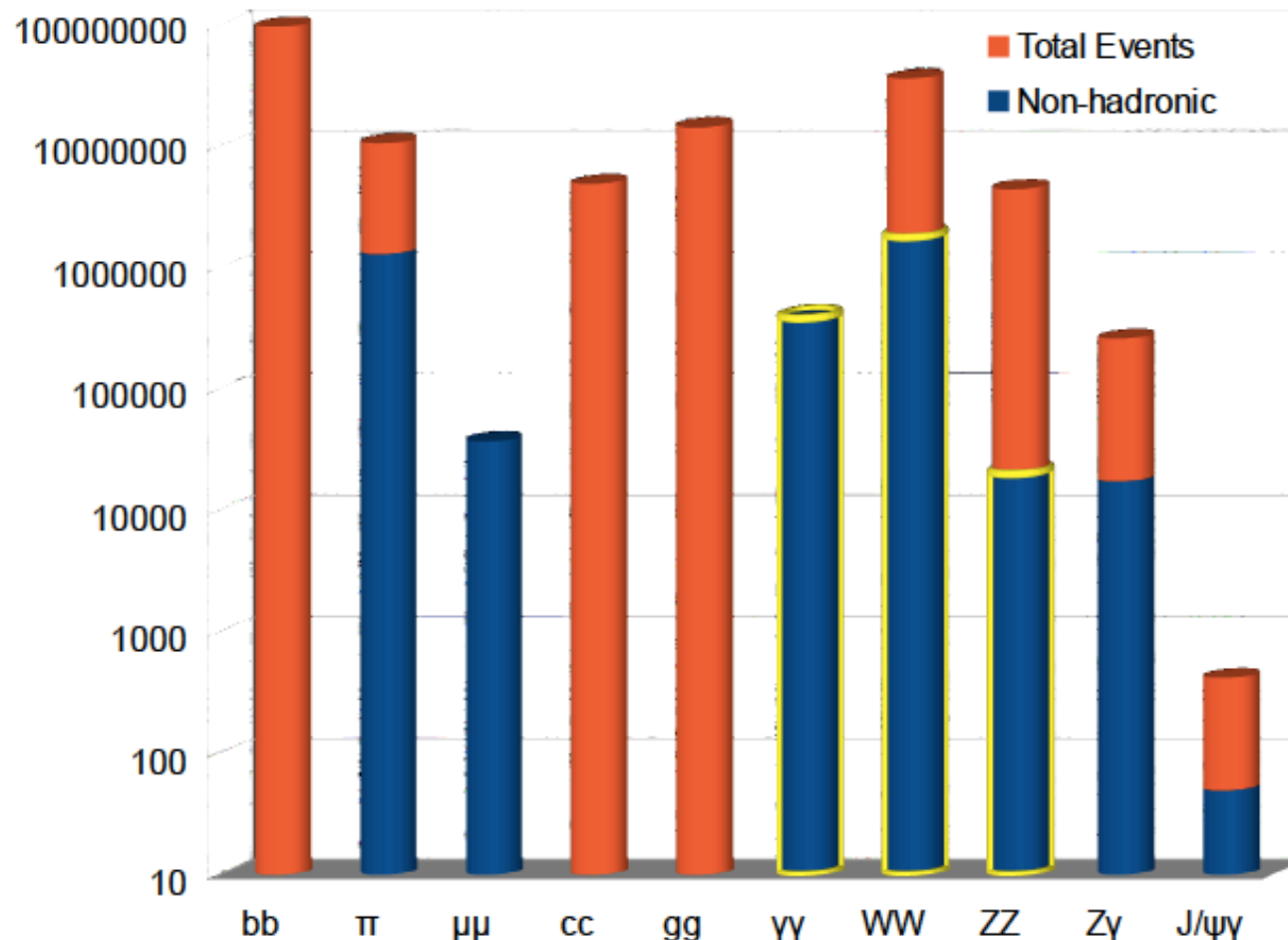



H → ZZ* decomposition

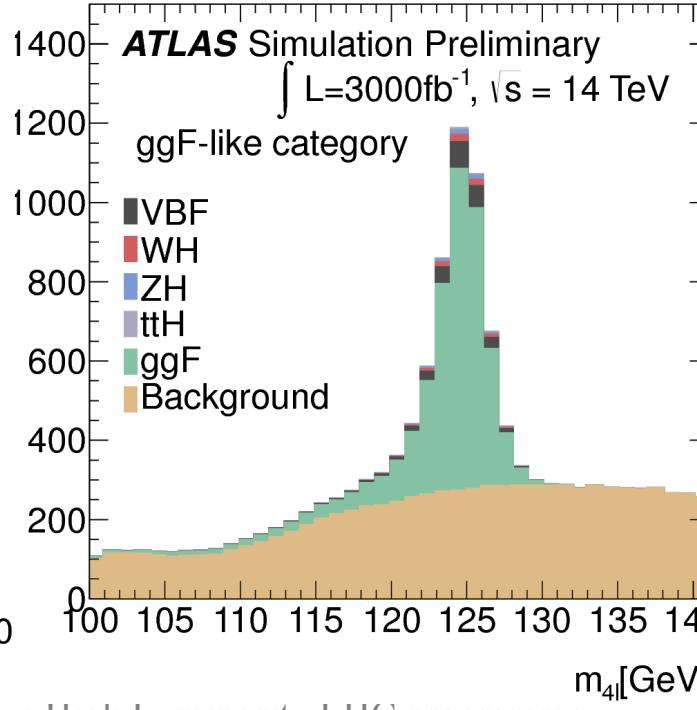
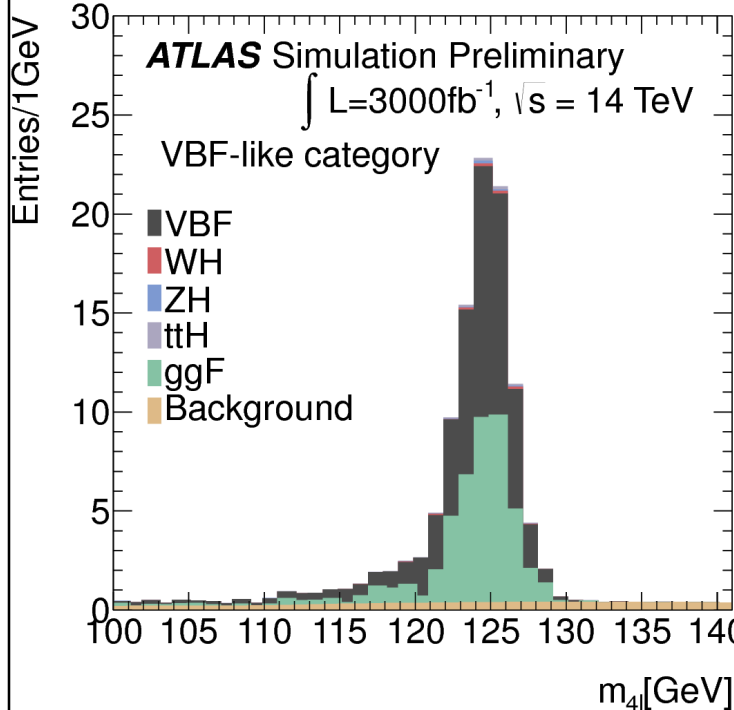
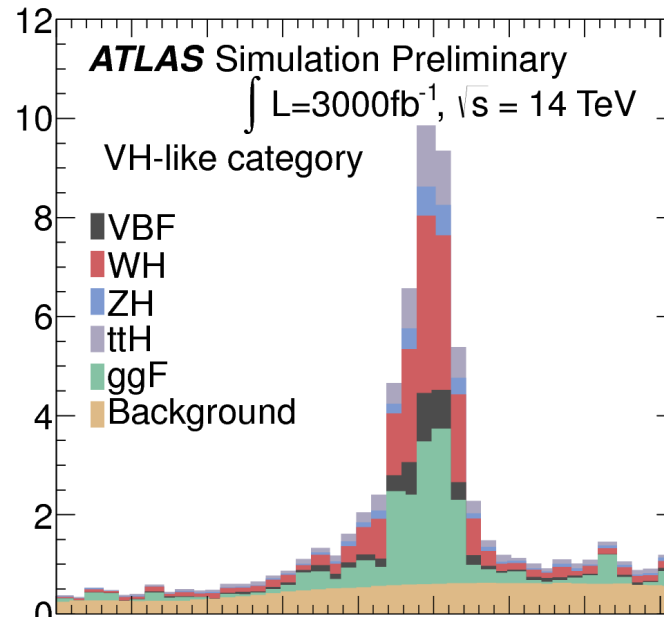
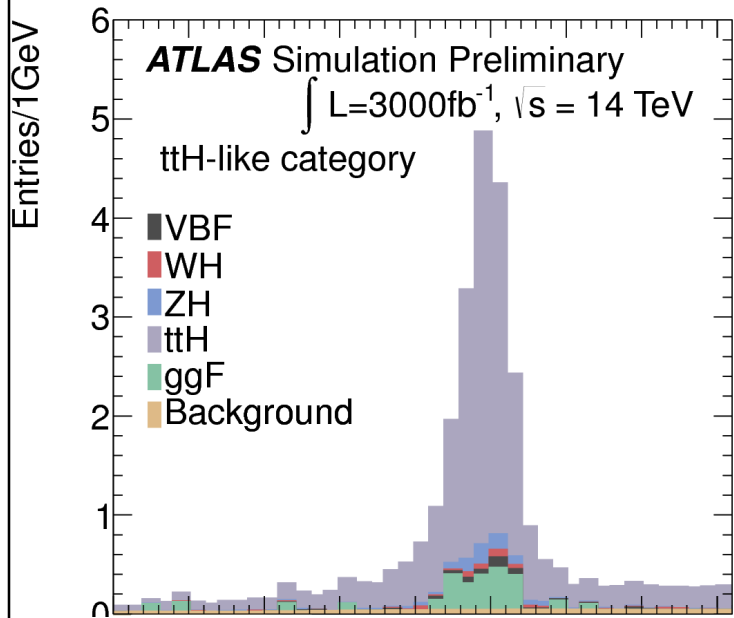

High purity channel:
 Possible to decompose
 into all production
 processes



- $\sim 2\sigma$ with 300fb^{-1} becomes
 $\sim 6\sigma$ with 3000fb^{-1}
- First direct measurement of Higgs coupling to 2nd generation fermions
 - Compare τ to μ couplings
- Possible to observe $t\bar{t}H$, $H \rightarrow \mu\mu$
 - Involves only fermion couplings
 - Relevant for CP violation studies
 - Only ~ 30 events in 3000fb^{-1} , but very pure: $s/b \sim 1$

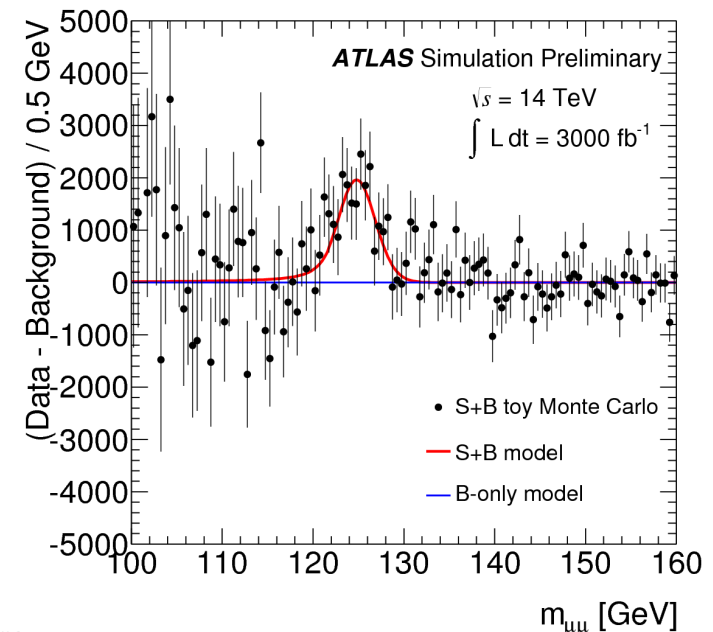
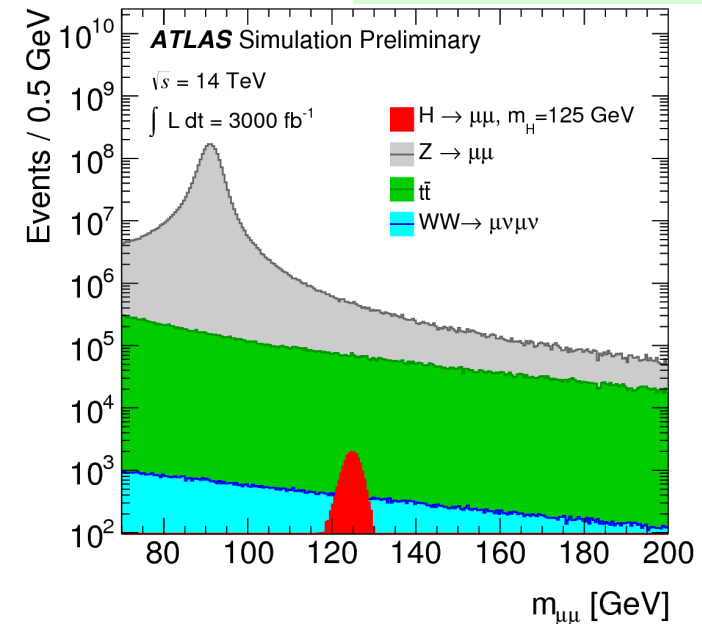



Rare Higgs decays: $H \rightarrow Z\gamma$

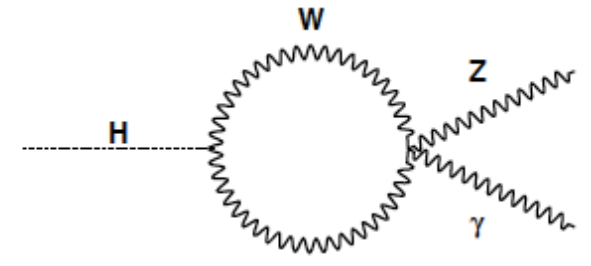
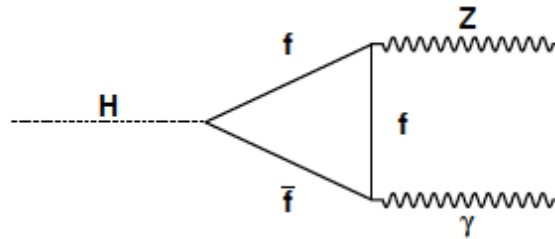
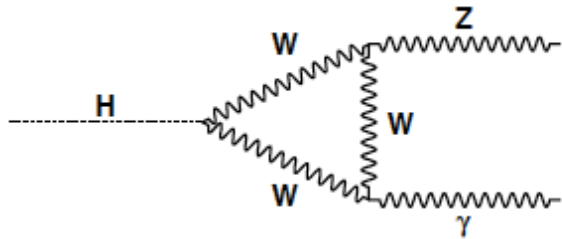

- Good test of the loop structure
 - Compare to $H \rightarrow \gamma\gamma$
- Marginal s/b, but measurement possible with 3000fb^{-1} thanks to good mass resolution

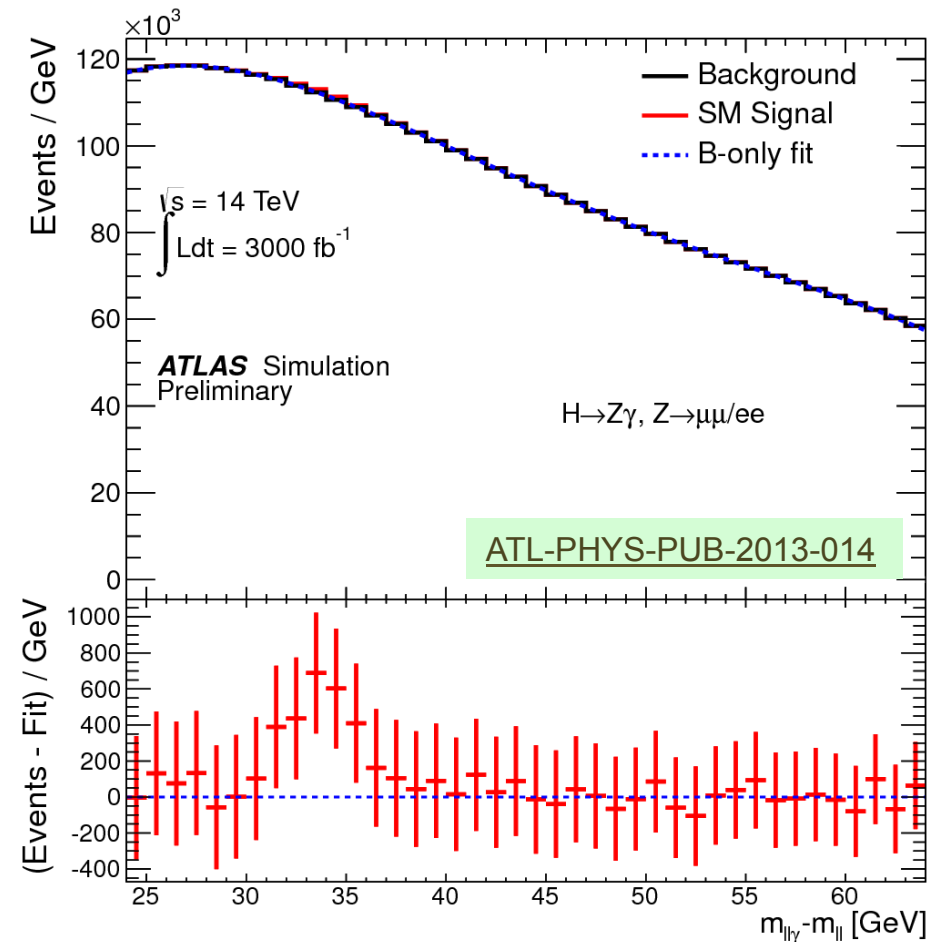



Signal strength and couplings

ATLAS Simulation Preliminary

$\sqrt{s} = 14$ TeV: $\int Ldt=300 \text{ fb}^{-1}$; $\int Ldt=3000 \text{ fb}^{-1}$

ATL-PHYS-PUB-2013-014

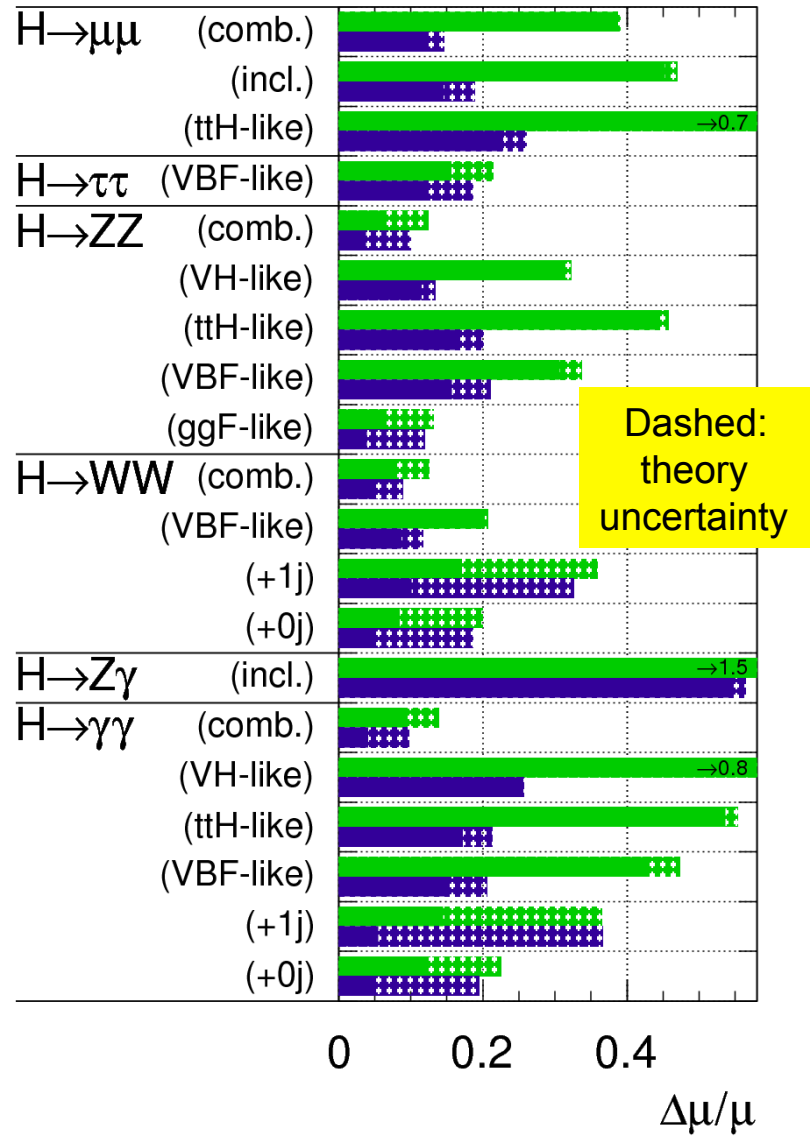

Minimal fit: only two coupling scale factors, κ_F for fermions and κ_V for vector bosons

- No BSM contributions in either loops or in the total Higgs width

Sensitivity without (with) theory uncertainties:

ATLAS	300 fb^{-1}	3000 fb^{-1}
K_V	3.0 % (5.6 %)	1.9 % (4.5 %)
K_F	8.9 % (10 %)	3.6 % (5.9 %)

A big improvement, esp. on κ_F , with 3000 fb^{-1} provided the theory uncertainties are reduced!



Couplings

J.Olsen at Snowmass/Seattle

CMS Projection (Prelim.)

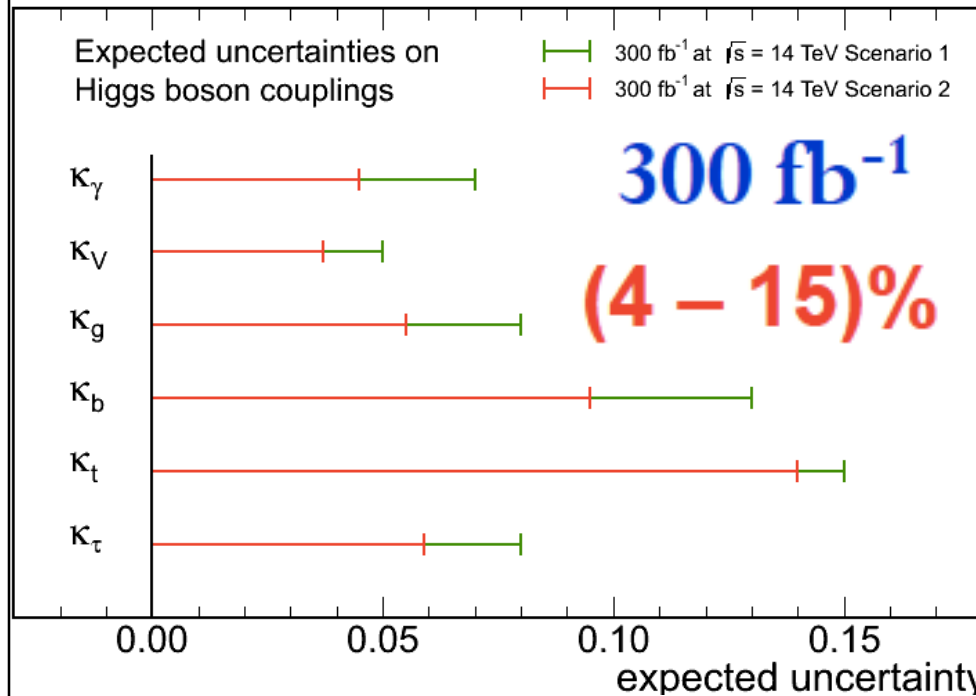

CMS Projection (Prelim.)

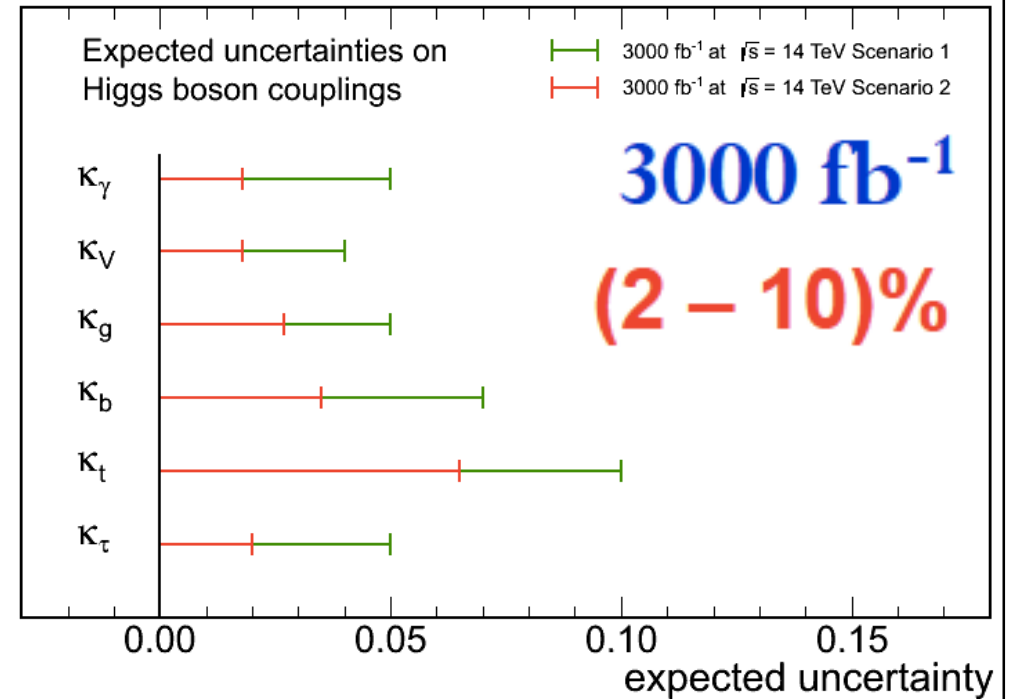

Numbers in brackets are % uncertainties on coupling deviations for [scenario 2, scenario 1]

L (fb^{-1})	κ_γ	κ_V	κ_g	κ_b	κ_t	κ_τ
300	[5, 7]	[4, 5]	[6, 8]	[10, 13]	[14, 15]	[6, 8]
3000	[2, 5]	[2, 3]	[3, 5]	[4, 7]	[7, 10]	[2, 5]

Ultimately, combined ATLAS+CMS precision down to a few %.



Invisible Higgs branching ratio

- Search for $ZH \rightarrow \ell\ell XX$
 - Needs good control of E_T^{mis}
- $BR(H \rightarrow XX)$ sensitivity
 - 23% with 300fb^{-1}
 - 8% with 3000fb^{-1}
- Other channels can add more sensitivity (e.g. VBF)
- Can be interpreted in terms of Dark Matter searches

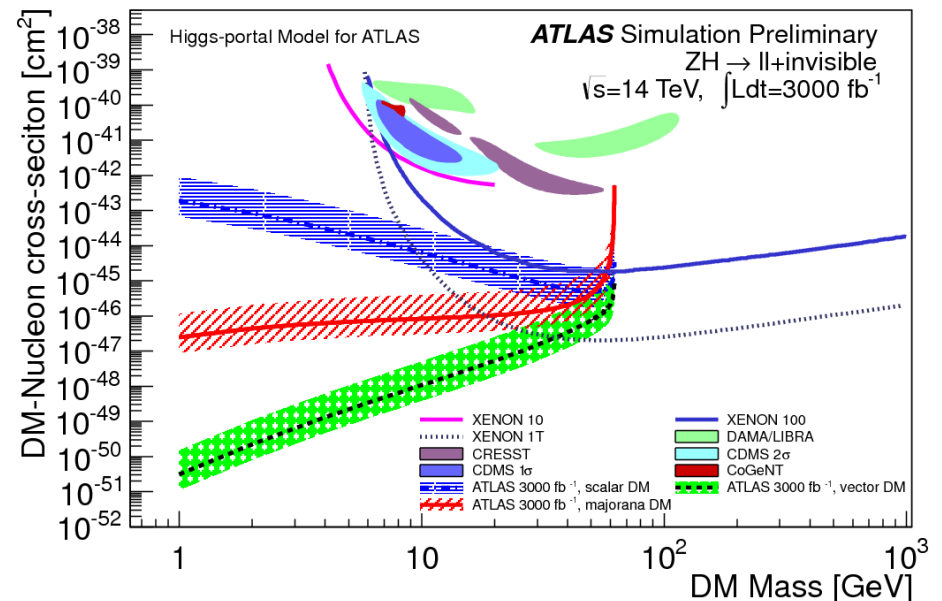
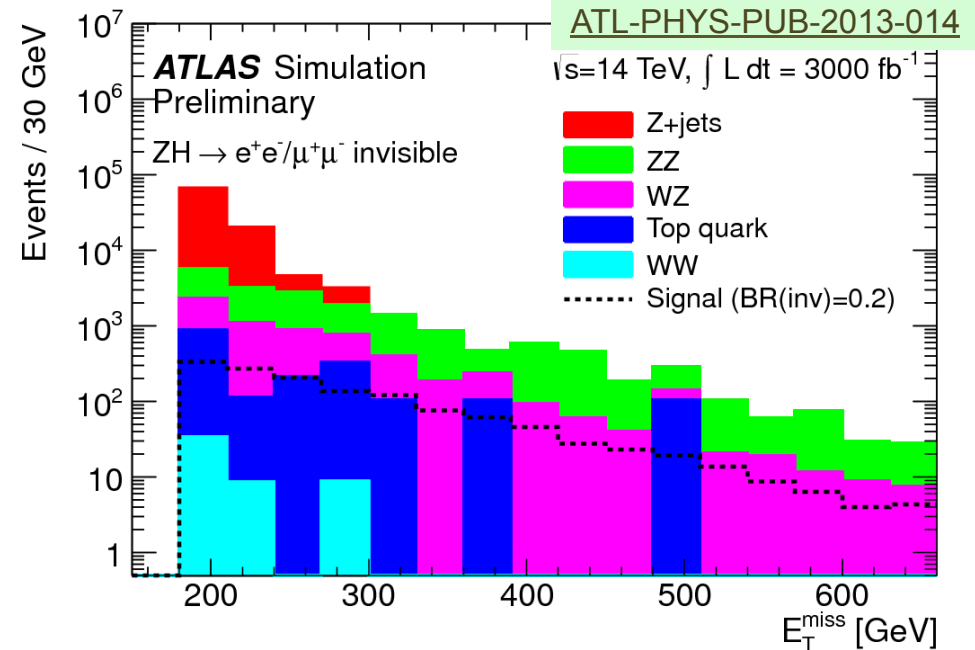



Important consistency check of the EWSB mechanism

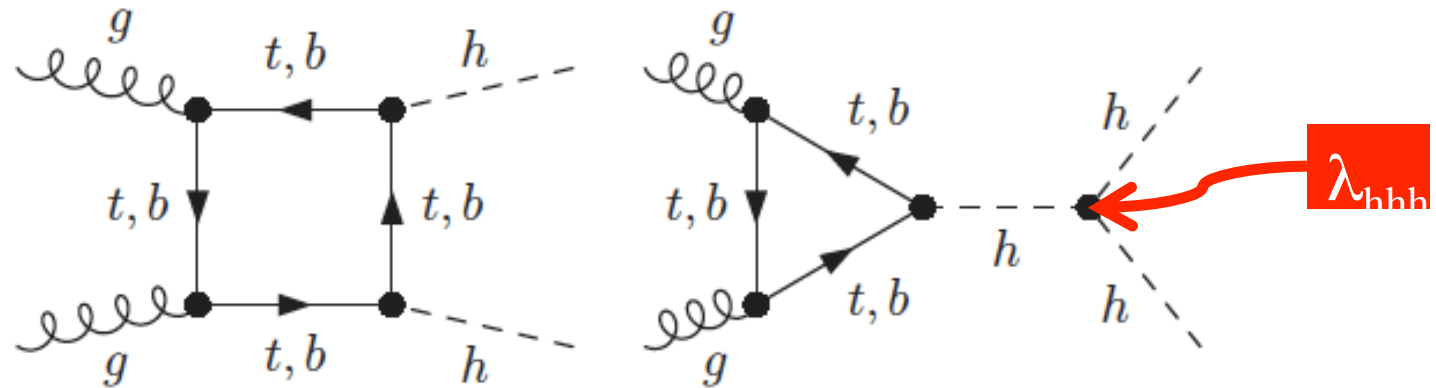

- Arguably, the most challenging measurement at the LHC!
 - Destructive interference with diagrams not containing the hhh vertex
 - For $\lambda_{HHH}/\lambda_{HHH}^{SM} = 0/1/2$, the cross section is 71/34/16fb
- Preliminary ATLAS studies indicate that $hh \rightarrow bb\gamma\gamma$ is promising
 - $\sigma \times BR \sim 0.1$ fb, backgrounds are largely $Xh(h \rightarrow \gamma\gamma)$ and continuum $bb\gamma\gamma$
 - Additional signal channels under study, e.g. bb - bb , $bb\tau\tau$
- A $\sim 3\sigma$ measurement by ATLAS+CMS with 3000fb^{-1} seems possible

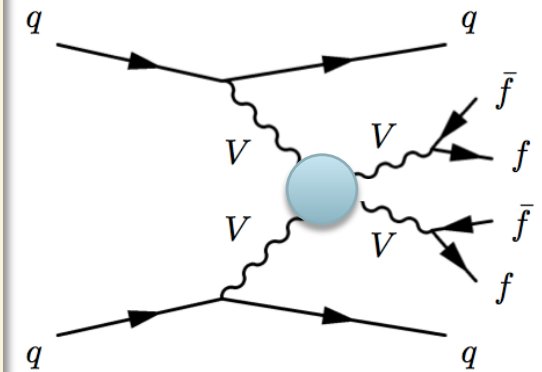
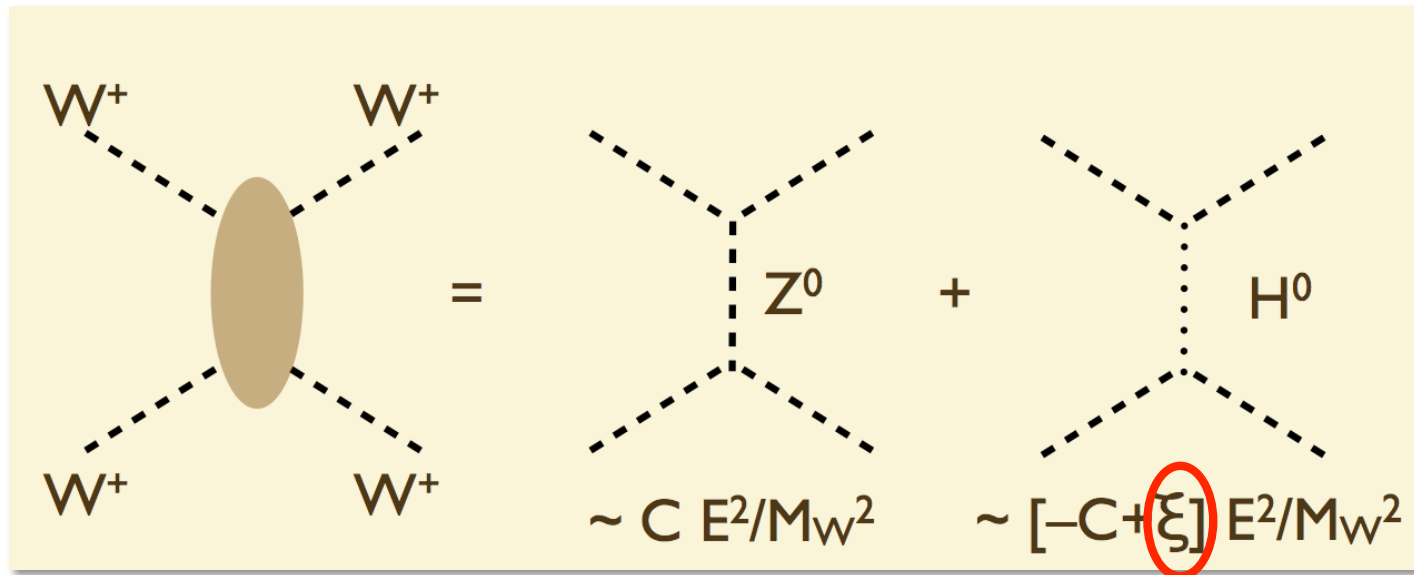

- Provides insight into the dynamics of EW symmetry breaking
 - Important closure test of the Standard Model
 - In SM with Higgs, $\xi=0$; $\xi \neq 0$, would be sign for new (resonant and/or non-resonant) physics
 - If $\xi \neq 0$, important to study as many final states as possible (WW/WZ/ZZ) in order to learn the most about the new dynamics



Vector Boson Scattering

- Big gains in sensitivity from 300fb^{-1} to 3000fb^{-1}
 - Factor ~ 3 improvement in measuring the Standard Model σ_{VBS}
 - Factor ~ 2 better sensitivity to models predicting TeV-scale resonances

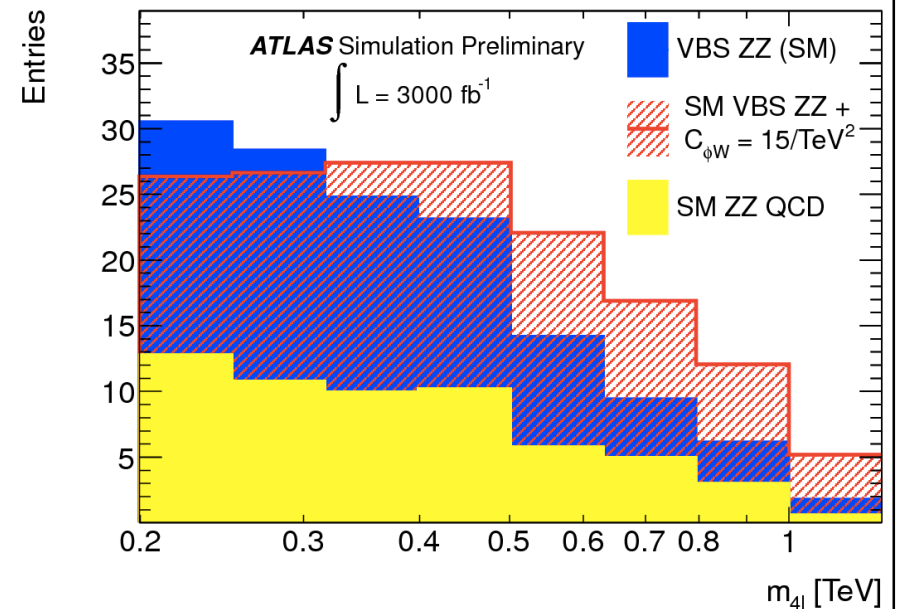
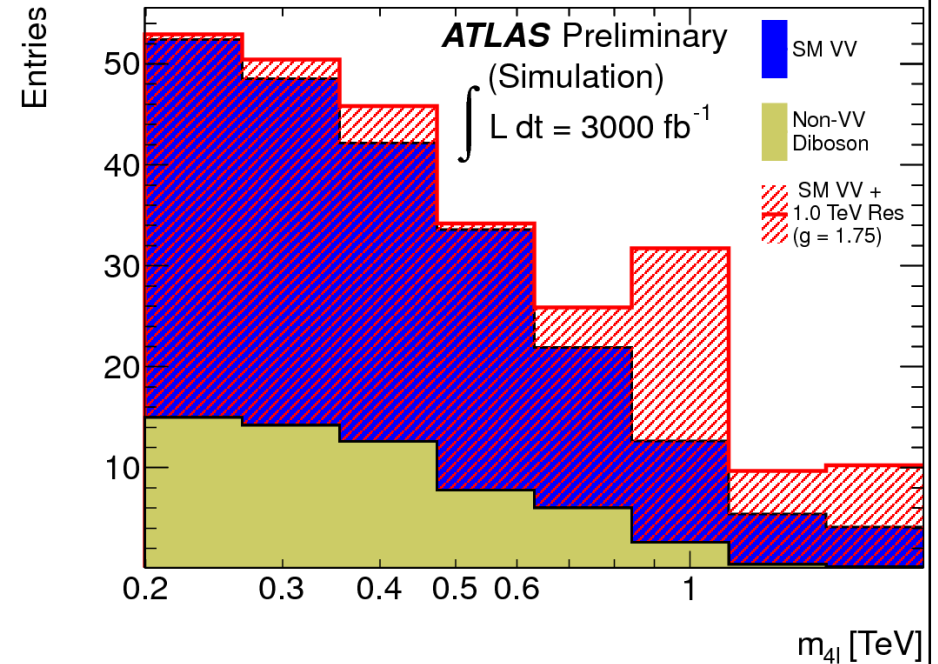
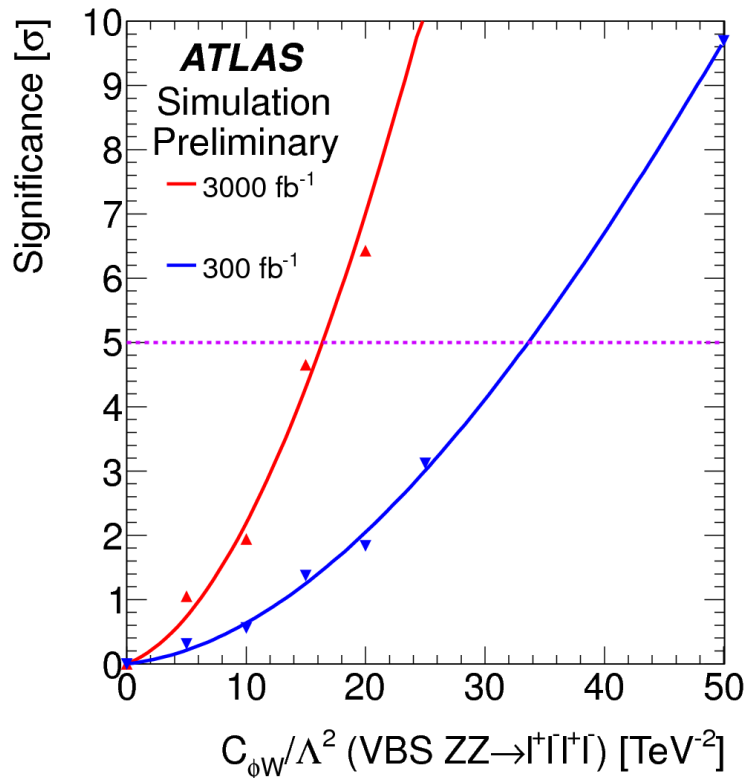



The “unbearable lightness” of M_H

Observed mass
(~125GeV)

$$M_H^2 = M_{\text{bare}}^2 + \left(\text{Higgs self-energy loop} \right) + \left(\text{top quark loop} \right) + \left(\text{W/Z loop} \right)$$

Bare mass to cancel radiative corrections

Radiative corrections, top loop dominates: $\sim m_t^2 \Lambda^2$
 Λ^2 : the energy scale at which the SM breaks down

If Λ was the Planck scale ($\sim 10^{19}\text{GeV}$), one would need a cancellation to 33 digits!

Fine tuning!

Even for $\Lambda=10\text{TeV}$ the fine tuning is at the per mille level!

Strongest motivation for new physics at TeV scale



SUSY: one way to avoid fine tuning



In SUSY, the stop loop would cancel the top loop contribution to the Higgs mass.
 But cancellation only works if stop mass is not much heavier than top mass.
 Stop cannot be heavier than $O(\sim 1\text{TeV})$.

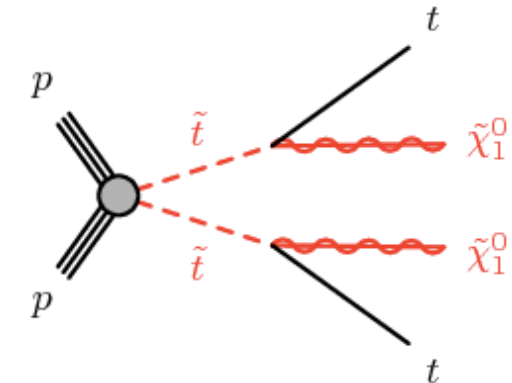
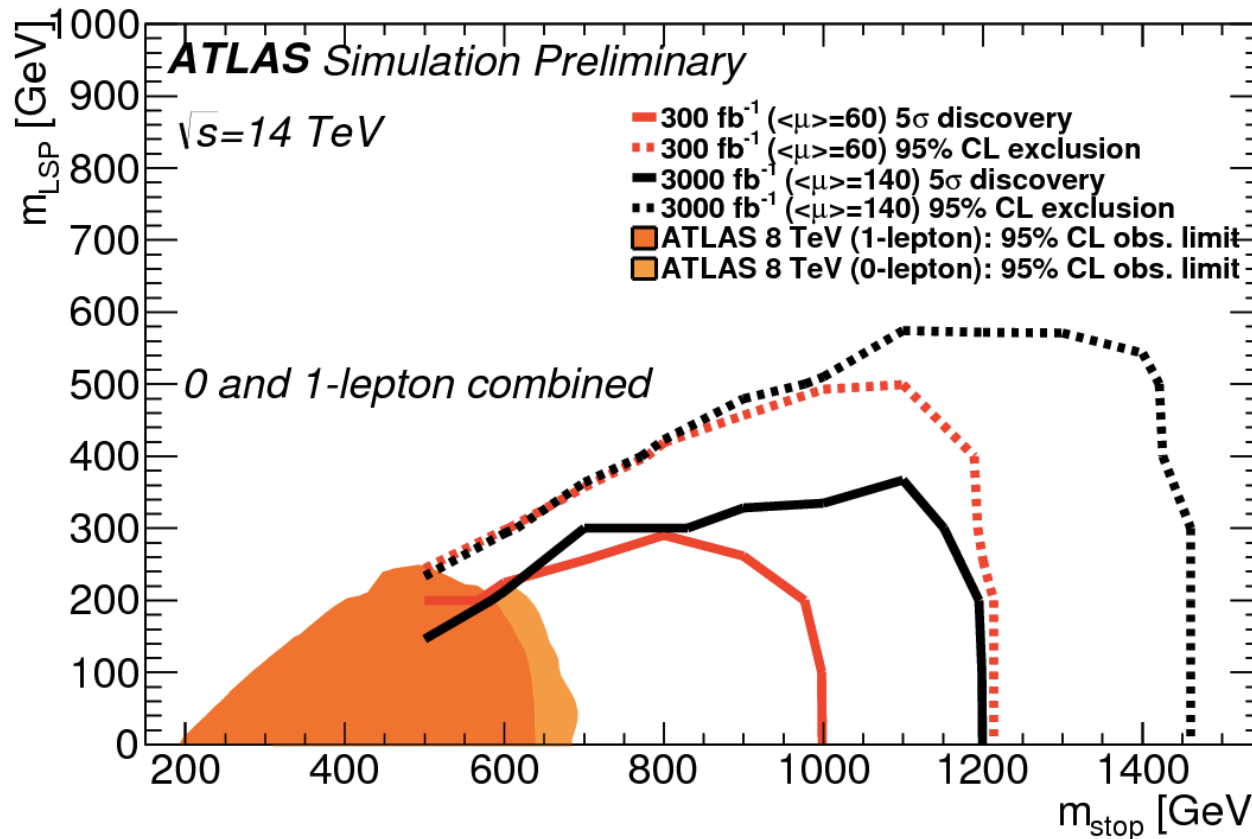

20% increase in reach
 with 3000fb⁻¹ may
 prove vital



Exploration of the Multi-TeV scale

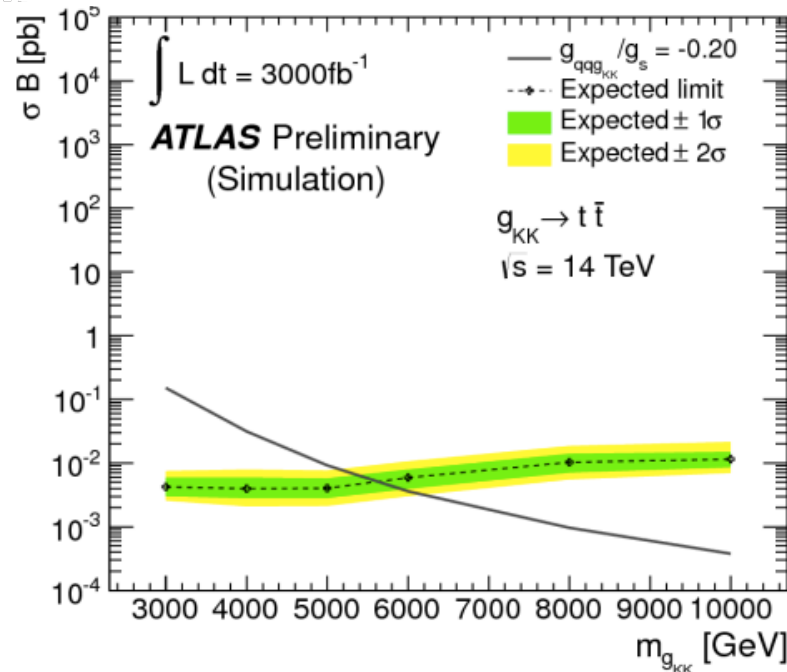

model	300 fb ⁻¹	1000 fb ⁻¹	3000 fb ⁻¹
g_{KK}	4.3 (4.0)	5.6 (4.9)	6.7 (5.6)
Z'_{topcolor}	3.3 (1.8)	4.5 (2.6)	5.5 (3.2)

Sensitivity improvements up to 50% in the multi-TeV scale

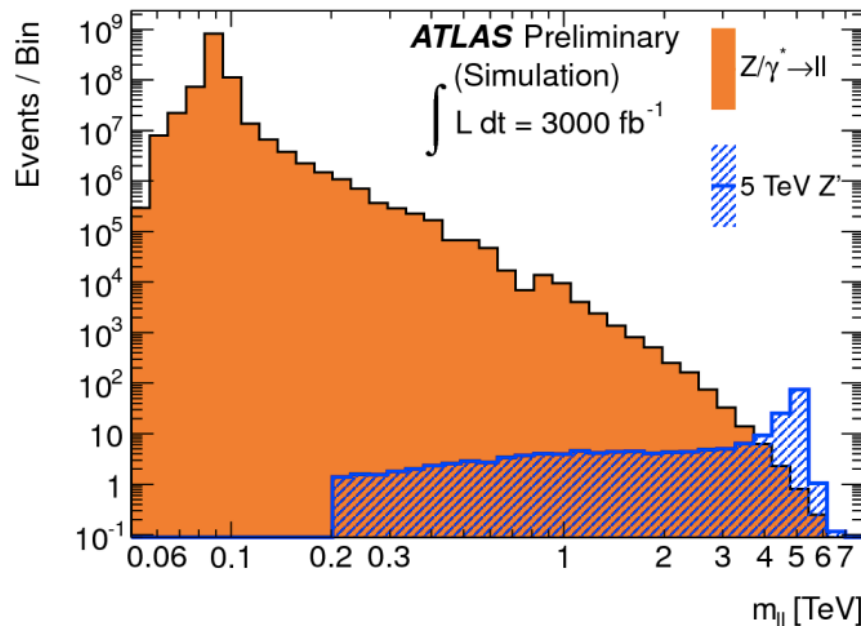

model	300 fb ⁻¹	1000 fb ⁻¹	3000 fb ⁻¹
$Z'_{SSM} \rightarrow ee$	6.5	7.2	7.8
$Z'_{SSM} \rightarrow \mu\mu$	6.4	7.1	7.6



LHC upgrades: How to deliver 3000fb^{-1}

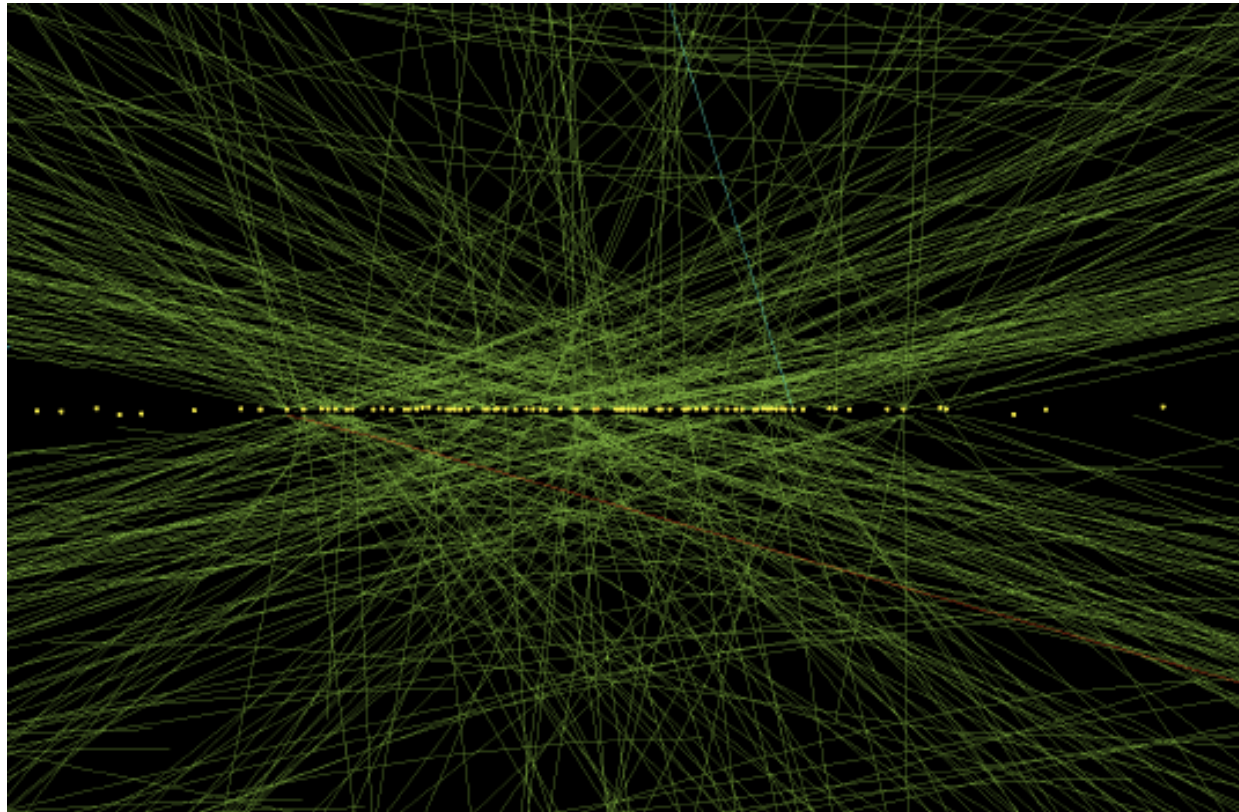

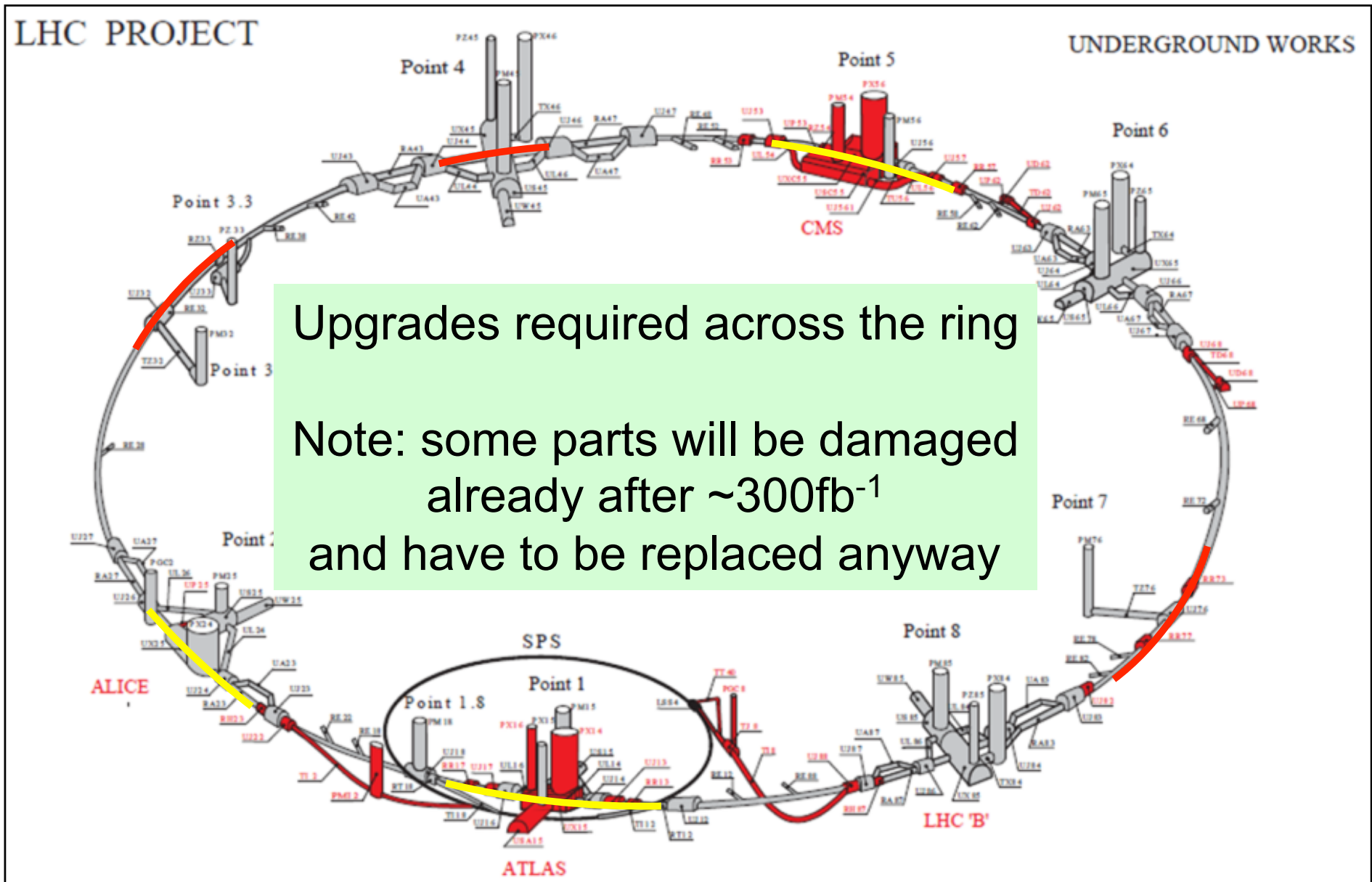



- Replace components damaged by radiation after $\sim 300\text{fb}^{-1}$
 - Stronger focusing magnets in ATLAS/CMS interaction regions
- Most important: luminosity levelling
 - Deliver max. integrated luminosity with lowest possible pile-up density
 - Main handles: **crab cavities** and **crab kissing**

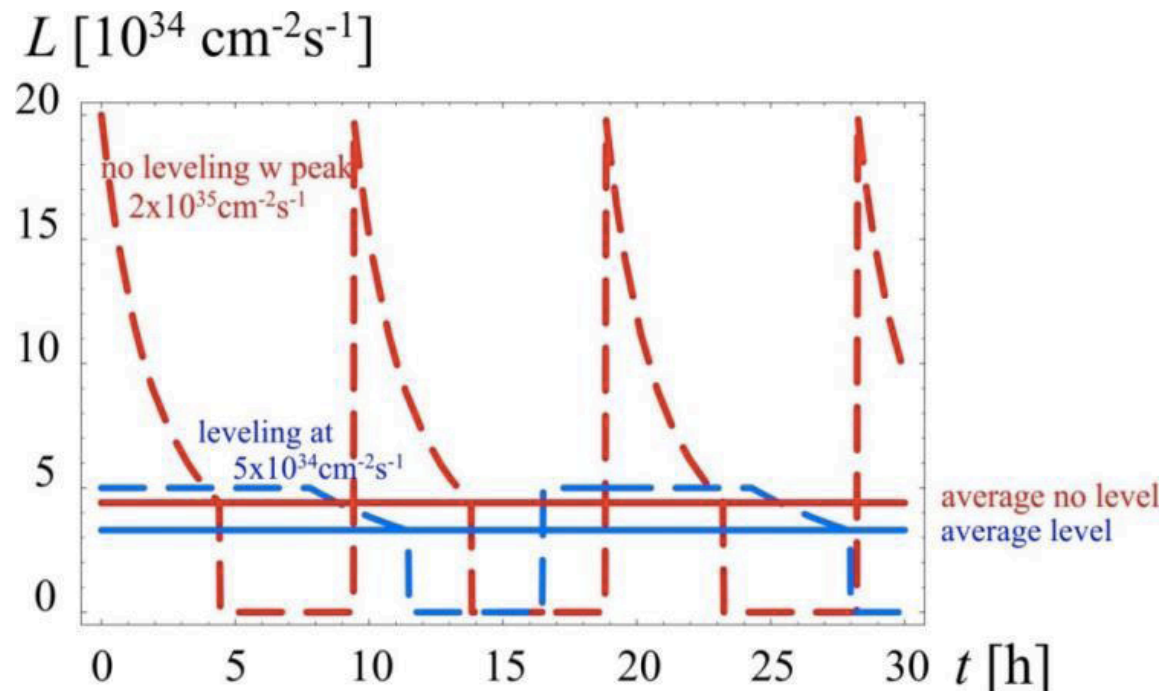



Crab kissing – impact on pile-up density

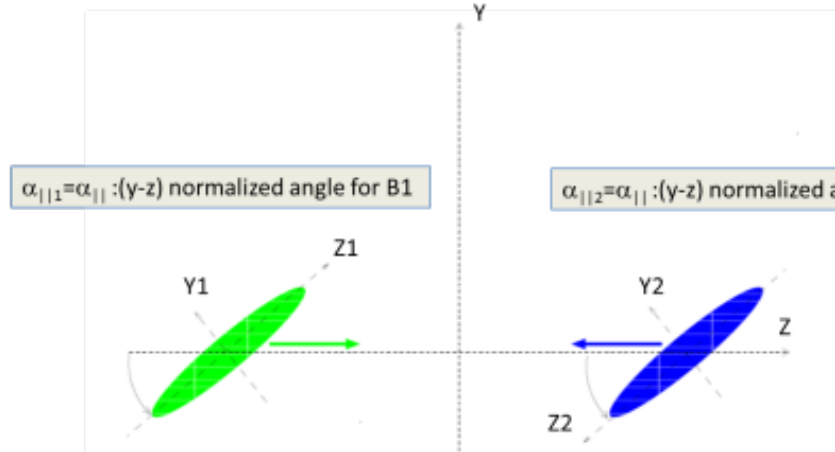
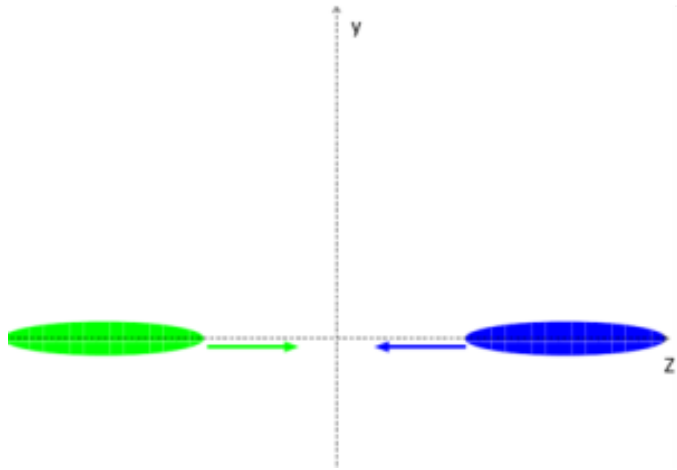

HL-LHC baseline and backup (25 ns): $250 \text{ fb}^{-1}/\text{y}$, $\mu_{\text{tot}} = 140$ @5E34
(BB wire .or. crab w/o CK scheme)

“HL-LHC+” (25ns): $250 \text{ fb}^{-1}/\text{y}$, $\mu_{\text{tot}} = 140$ @5E34
(BB wire .and. crabs with CK scheme)

“HL-LHC++” (25ns): $250 \text{ fb}^{-1}/\text{y}$, $\mu_{\text{tot}} = 140$ @5E34
(BB wire .and. crabs with CK scheme .and. 800 MHz)

LHC2012 (50 ns): $25 \text{ fb}^{-1}/\text{y}$, $\mu_{\text{tot}} = 40$ @7.5E33

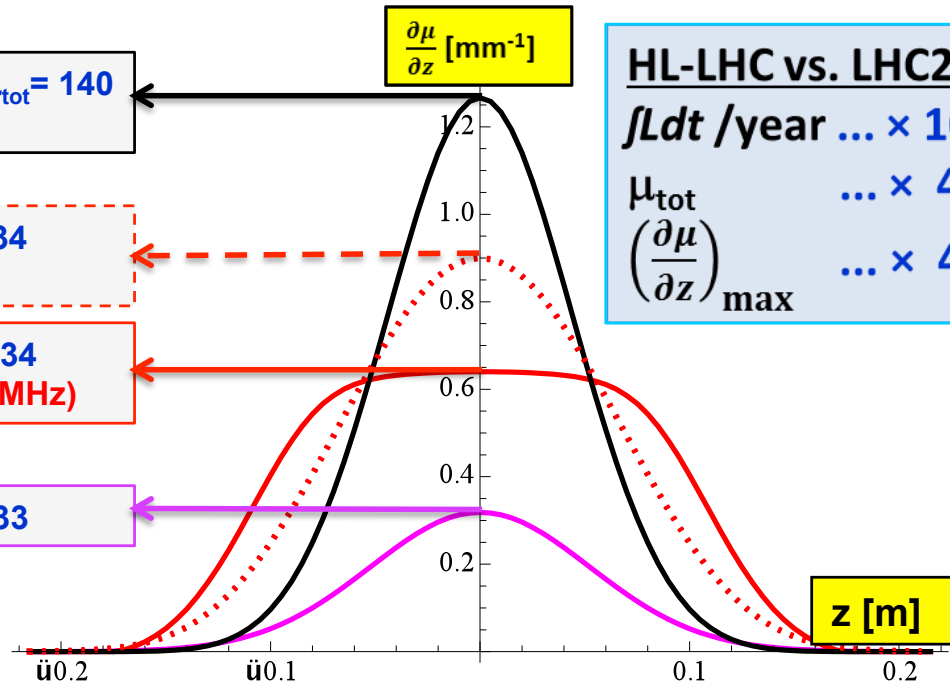

HL-LHC vs. LHC2012:

$\int L dt$ /year	... $\times 10$
μ_{tot}	... $\times 4$
$\left(\frac{\partial \mu}{\partial z}\right)_{\text{max}}$... $\times 4 \rightarrow 2$



How to collect efficiently 3000fb^{-1}

Upgrading ATLAS and CMS for HL-LHC

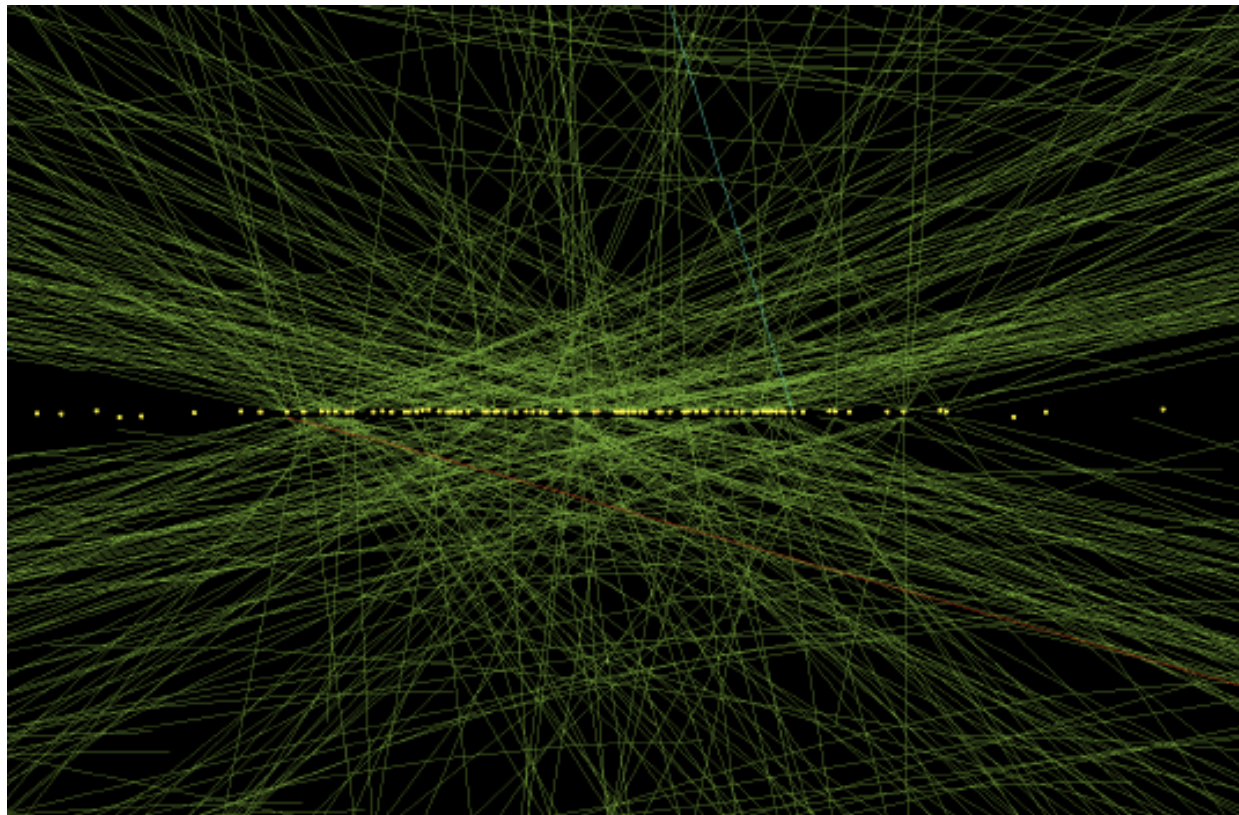



- Maintain (if possible, improve) today's performance at 5-10 times higher pile-up and instantaneous luminosity
- Survive 10 years of extreme irradiation!

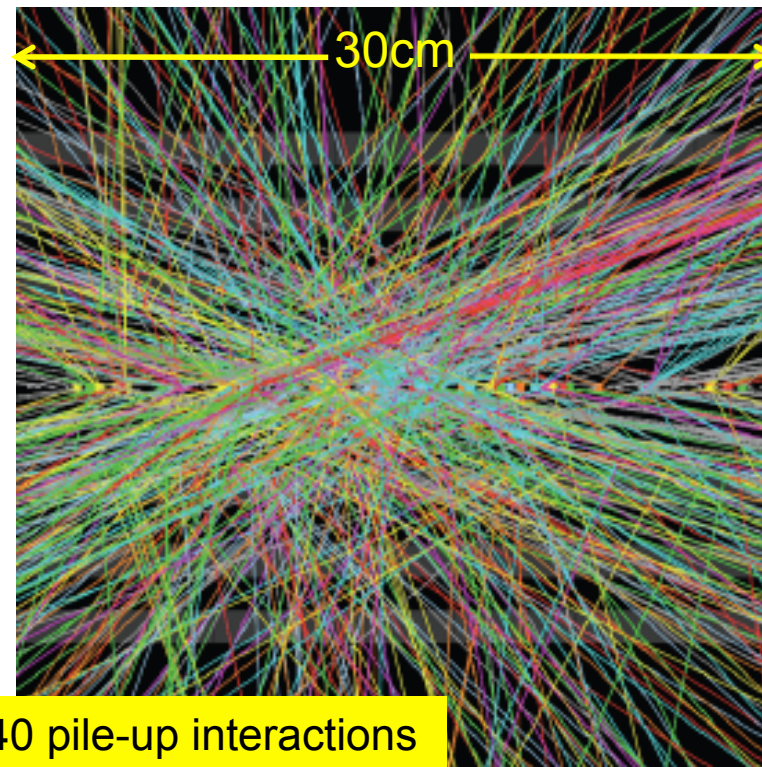
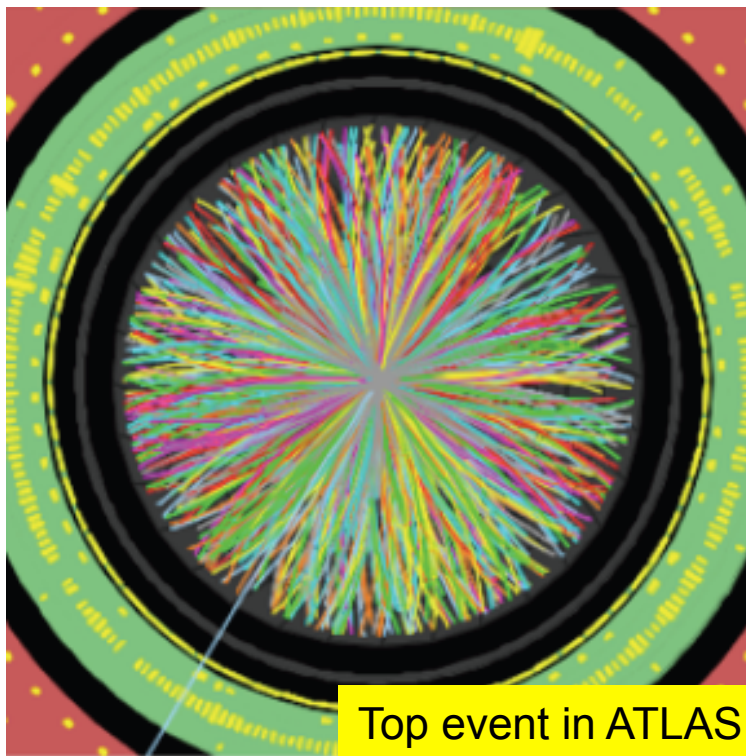

Top event in ATLAS with 140 pile-up interactions

Many systems need upgrading, but most importantly the Tracker and Trigger



- Current trackers must be replaced
 - They cannot withstand radiation beyond $\sim 500\text{fb}^{-1}$
 - Finer granularity is needed for the pattern recognition at pile-up of ~ 140
 - The ATLAS TRT (drift tubes) reaches such high level of occupancy that it becomes inoperable
 - Not enough bandwidth to readout the high volume of data
 - Need to provide info for the Level-1 Trigger
 - Current L1 Trigger uses only coarse granularity Calo and Muon information

ATLAS TRACKER UPGRADE

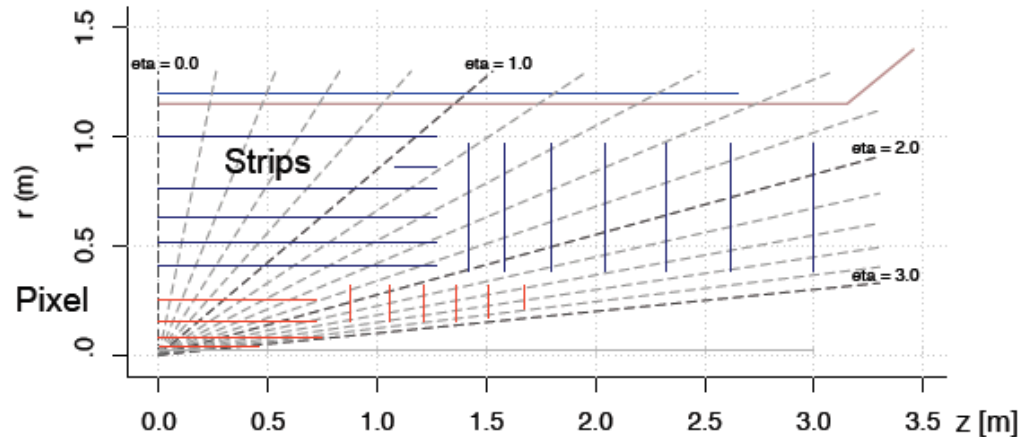

	Silicon Area	Channels [10 ⁶]
Pixel	8.2m ²	638
Strip	193m ²	74

- Baseline layout optimized for tracking performance
- Full simulation of tracker with Lol layout including service layout
- Biggest changes compared to current tracker:
 - pixels system extends out to larger radii
 - more pixel hits in forward direction to improve tracking
 - smaller pixels and short inner strips to increase granularity
 - outer active radius slightly larger to improve momentum resolution

- Remove Transition Radiation Tracker (TRT) as occupancy is too high during HL-LHC
- Install new all-Silicon tracker with pixels and strips
- Granularity increase by factor >4

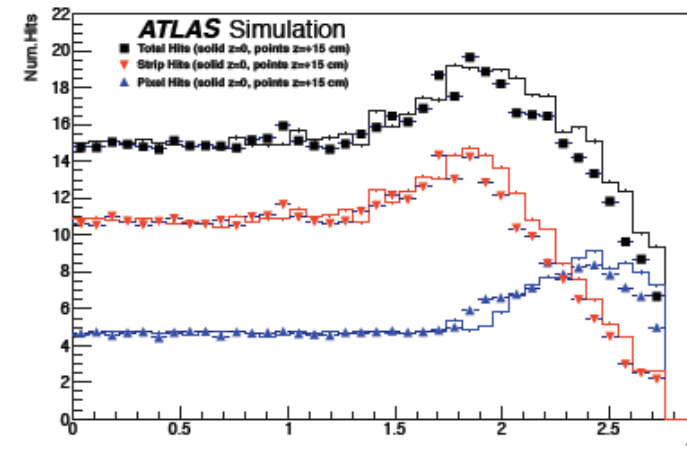

Ingrid-Maria Gregor, DESY - Overview of Tracking Detectors

15

ATLAS TRACKER UPGRADE

	Silicon Area	Channels [10^6]
Pixel	8.2m ²	638
Strip	193m ²	74

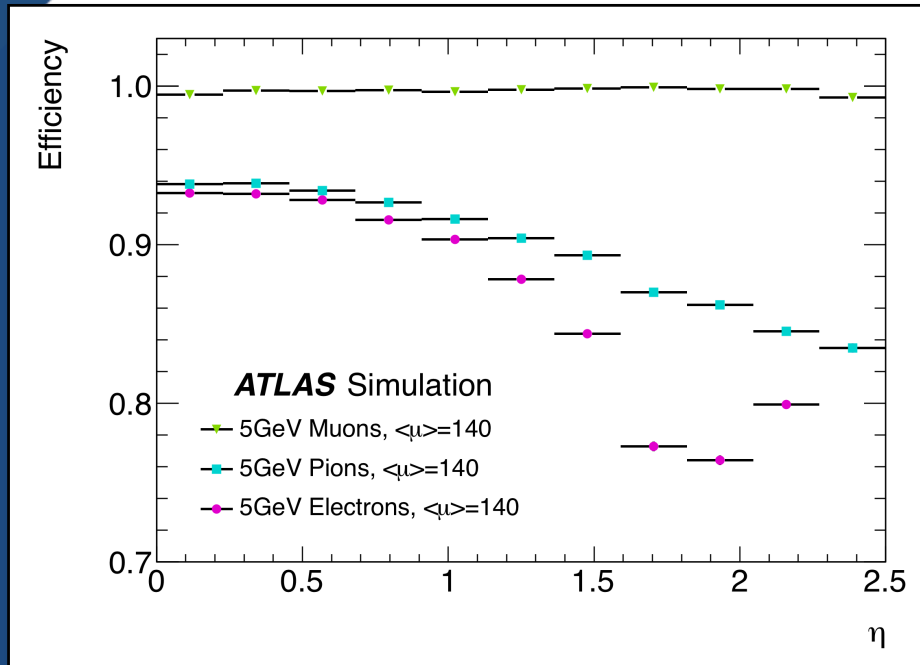

- Biggest changes compared to current tracker:
 - pixels system extends out to larger radii
 - more pixel hits in forward direction to improve tracking
 - smaller pixels and short inner strips to increase granularity
 - outer active radius slightly larger to improve momentum resolution

- Remove Transition Radiation Tracker (TRT) as occupancy is too high during HL-LHC
- Install new all-Silicon tracker with pixels and strips
- Granularity increase by factor >4

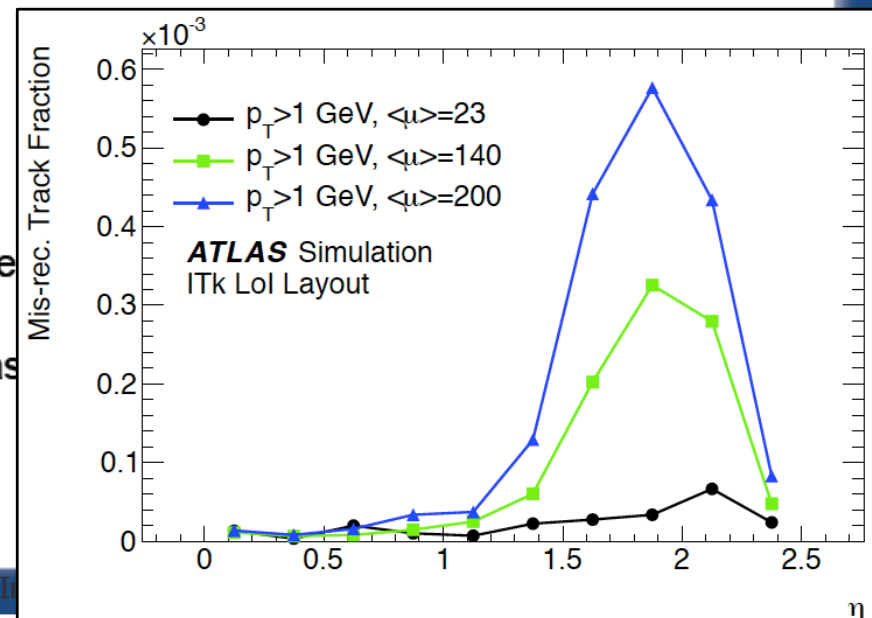



“Short strips”: Lead role in entire programme: hybrid/module/stave design, to powering & readout, to mechanics & integration

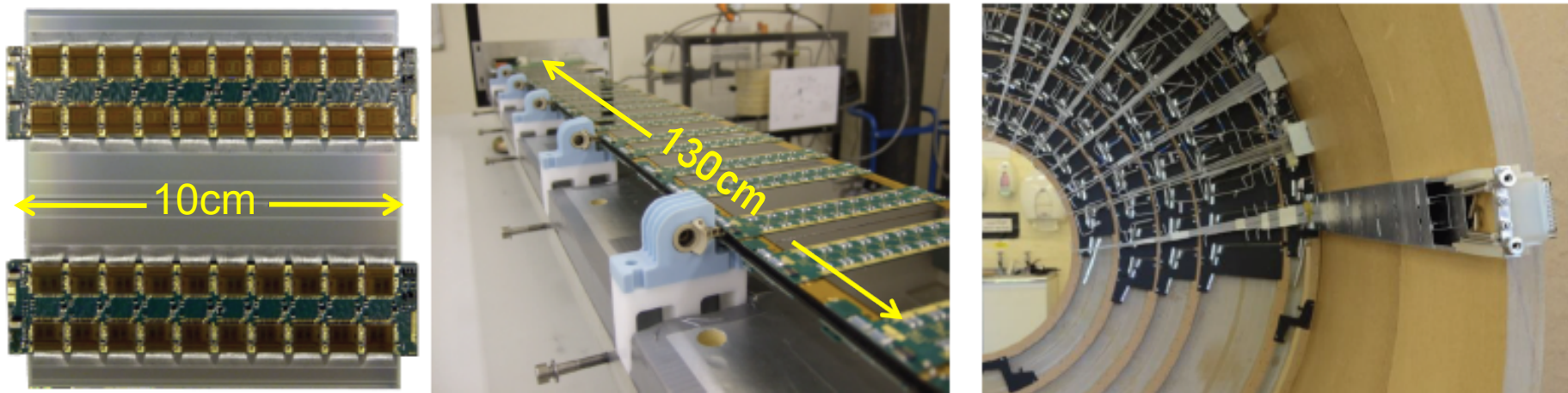
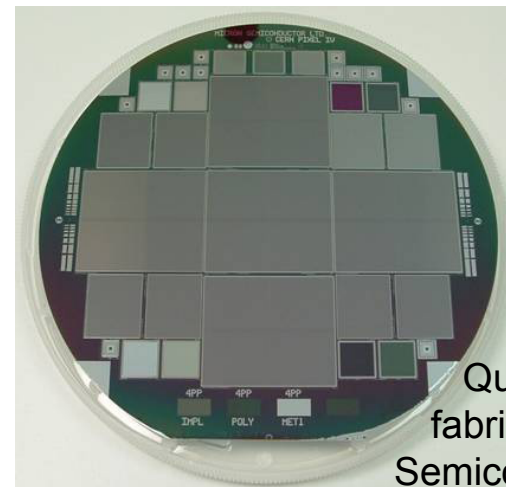
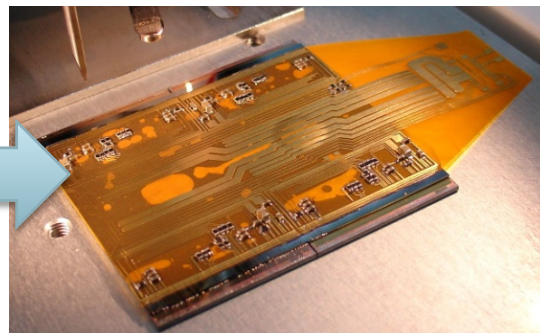

Figure 11: (Left) A strip module with hybrids, (middle) a thermo-mechanical strip stave and (right) the end of the barrel services mock-up

Pixels: Development & construction of forward pixel disks, R&D on sensors

Quad module Prototype (4x4cm²)



Quad sensor masks fabricated with Micron Semiconductor (UK) Ltd



How forward should tracking go?

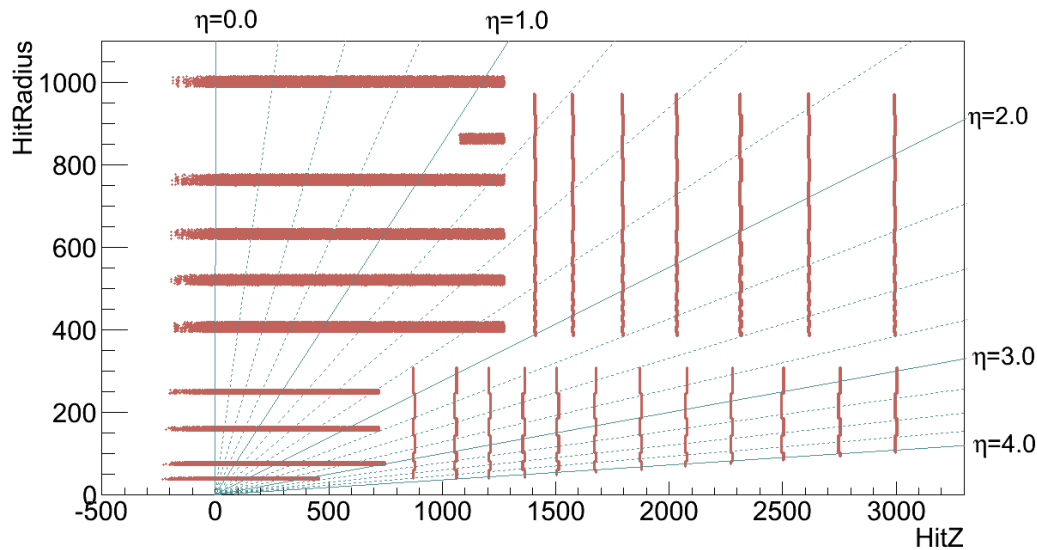

Consider benefits from forward tracking: $\sim 2.5 > |\eta| > \sim 4$

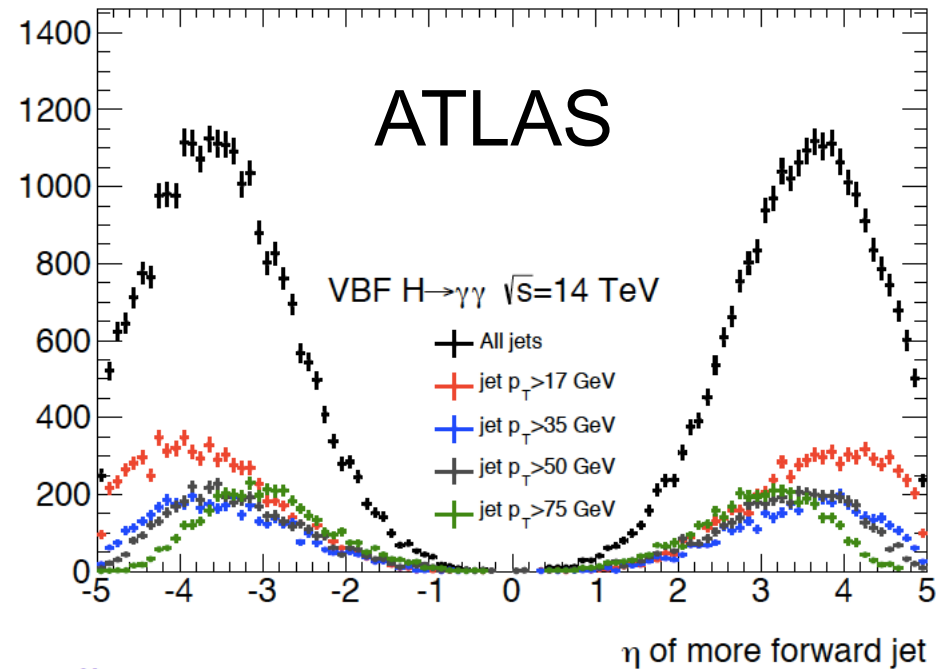
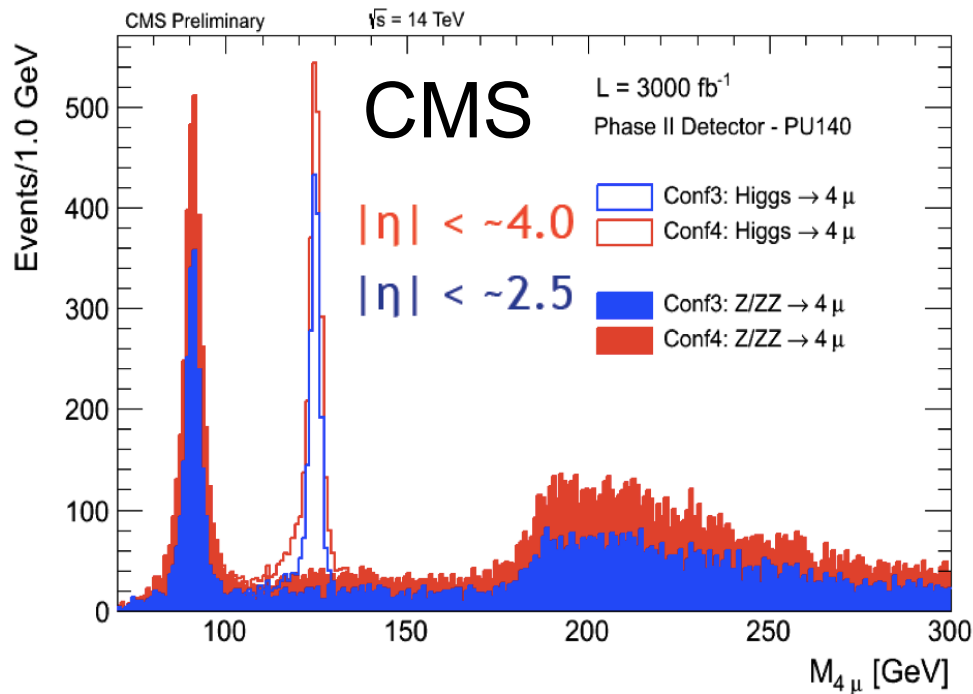



- Thanks to past experience construction can be more efficient
- But a much larger detector to be built!
- For a start-up in 2024, the detector must be ready on the surface by end of 2022, hence construction should start early in 2017
- Hence TDR and MoUs by end 2016
- Already a tight schedule, but feasible!



- Physics programme requires p_T thresholds similar to 2012 values in order to get maximum benefit from the 3000 fb^{-1}
- Main challenge is the (hardware) Level-1 trigger
- Improvements in L1 Calo and Muon systems not sufficient for achieving manageable rates with acceptable physics

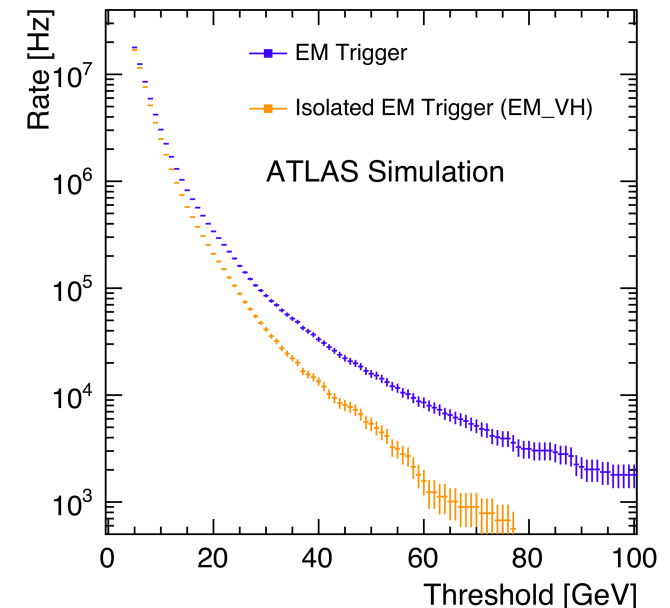
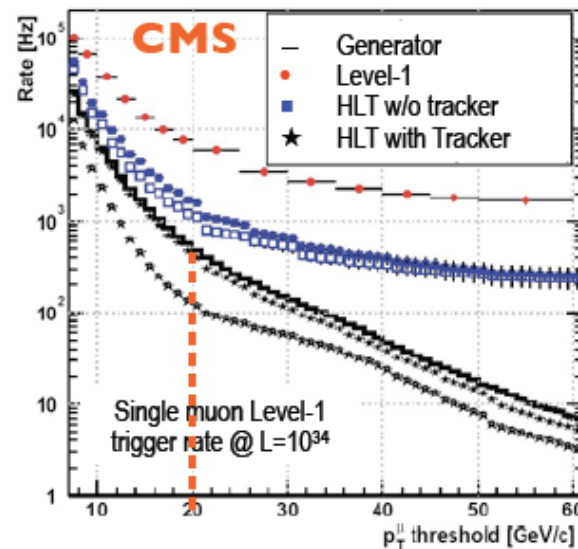
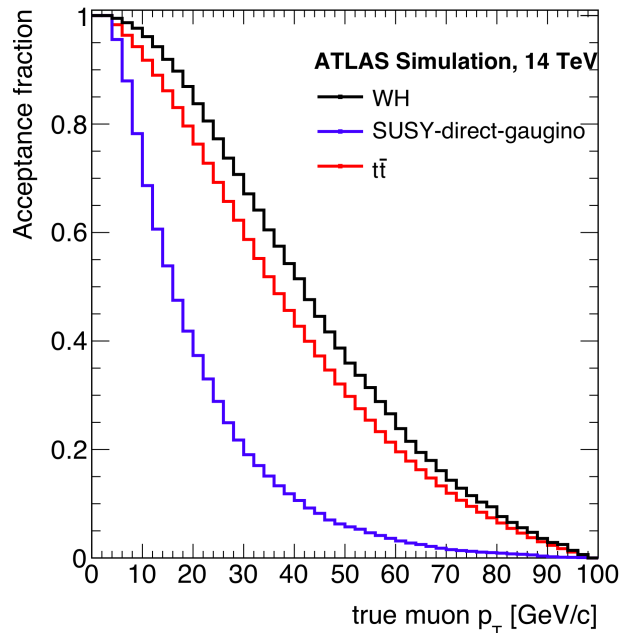



The benefits of tracking info at L1

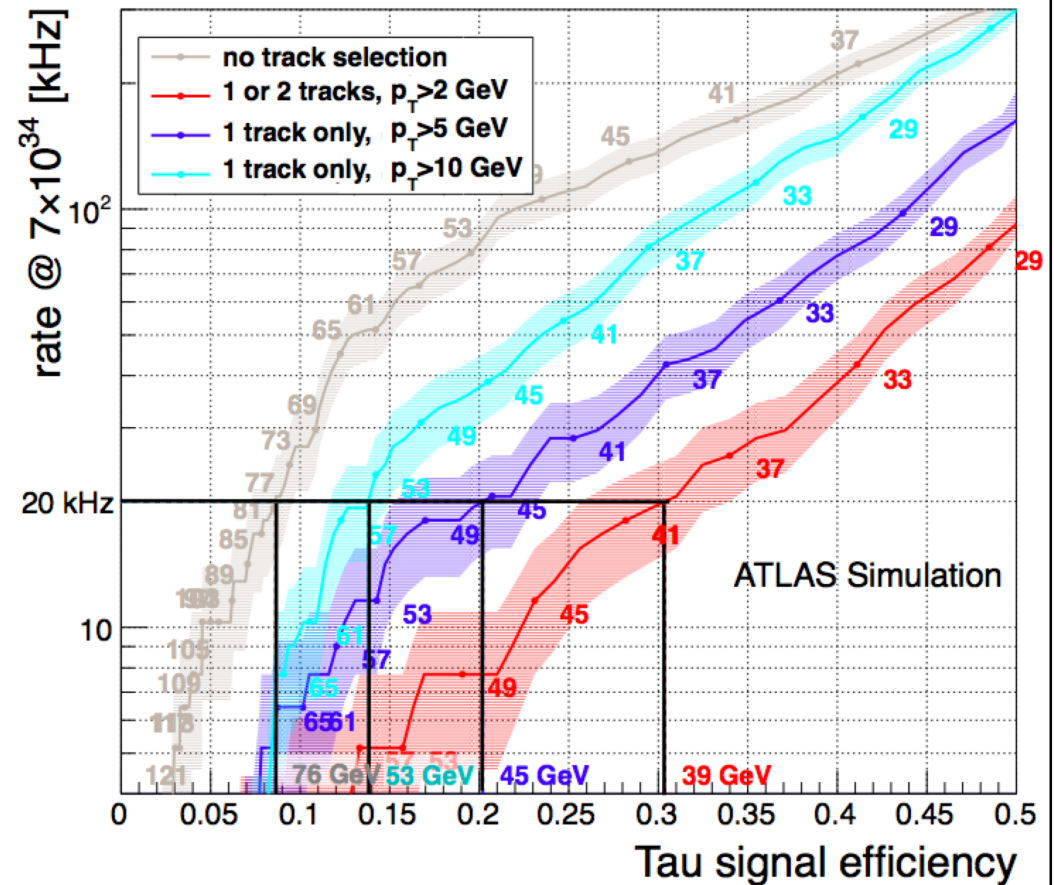
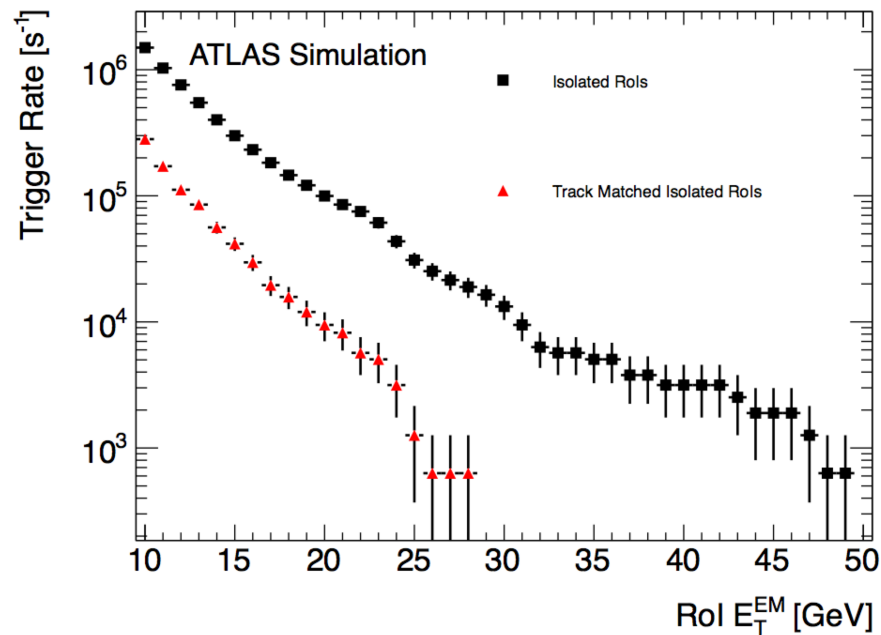
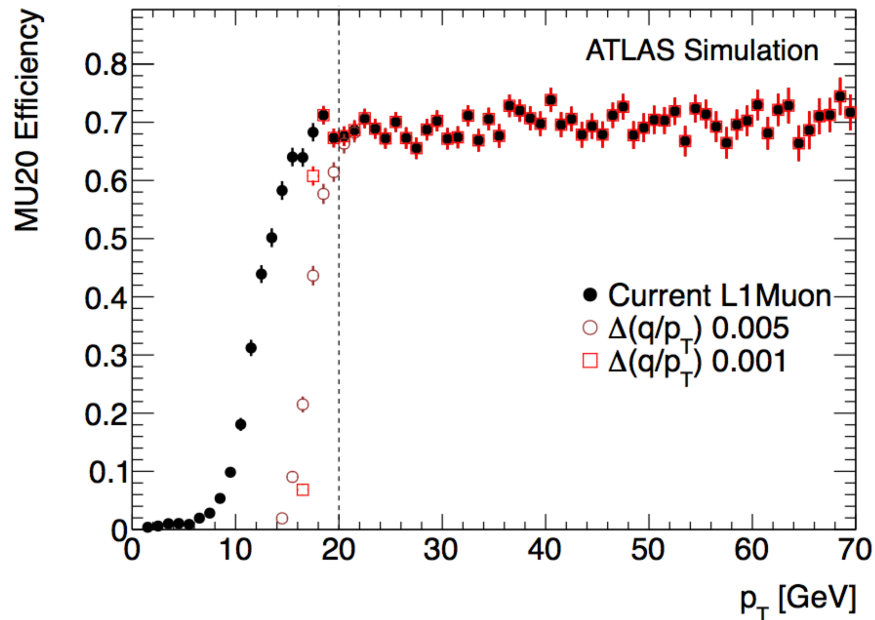



- Full tracker readout at 40MHz practically impossible
 - EITHER:
 - CMS** apply some **hit filtering at 40MHz** and bring off-detector a very small fraction of data, e.g. **only hits from high-pT tracks**
 - OR:
 - L1 in two steps:**
 - L0: reduce the rate from 40MHz to ~1MHz using Calo/Muon info**
 - L1: read out only interesting regions of the tracker at L0 rate for L1 decision**
- Optimal choice depends on additional boundary conditions
 - Second option requires increased latency: $L0+L1 \sim 20\mu s$
- A lot of R&D – final decisions are yet to be taken



- p_T filtering in stacked double layers of silicon wafers
 - Coincidence hits read out at 40MHz and combined off-detector to form track trigger primitives
- Major impact on the layout of the tracker

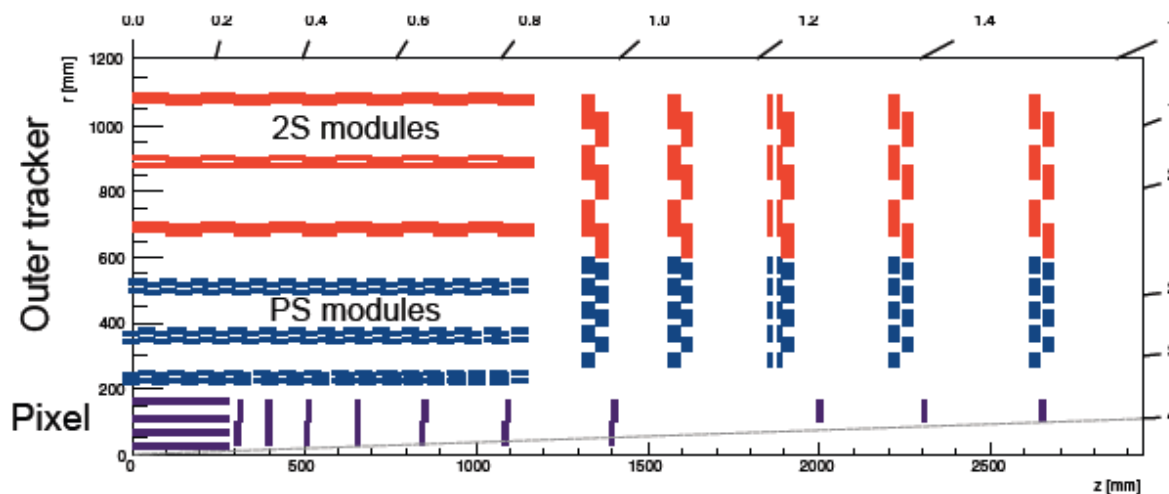
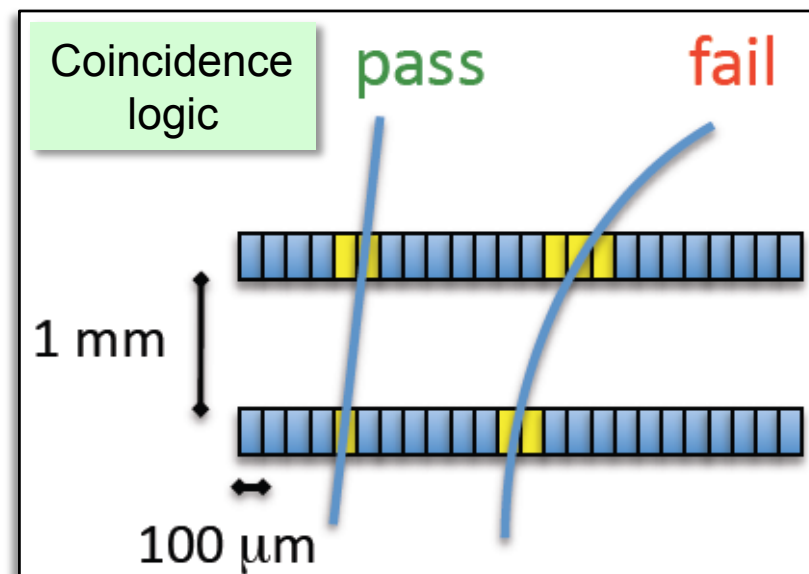

Baseline layout of CMS tracker



- Phase-I L1 trigger (Calo/Muon) becomes Phase-II L0
 - Latency: $\sim 3-5\mu\text{s}$; rate: 0.5-1.0MHz, synchronous
- From L0 to L1, bring in tracking and other new information
 - L1Track in Regions of Interest found by L0
 - Read out only $\sim 10\%$ of tracker at L0 rate (takes $\sim 6-7\mu\text{s}$)
 - Full granularity Calo and precision Muon chambers
 - Latency $\sim 15-17\mu\text{s}$; rate $< 200\text{kHz}$, asynchronous

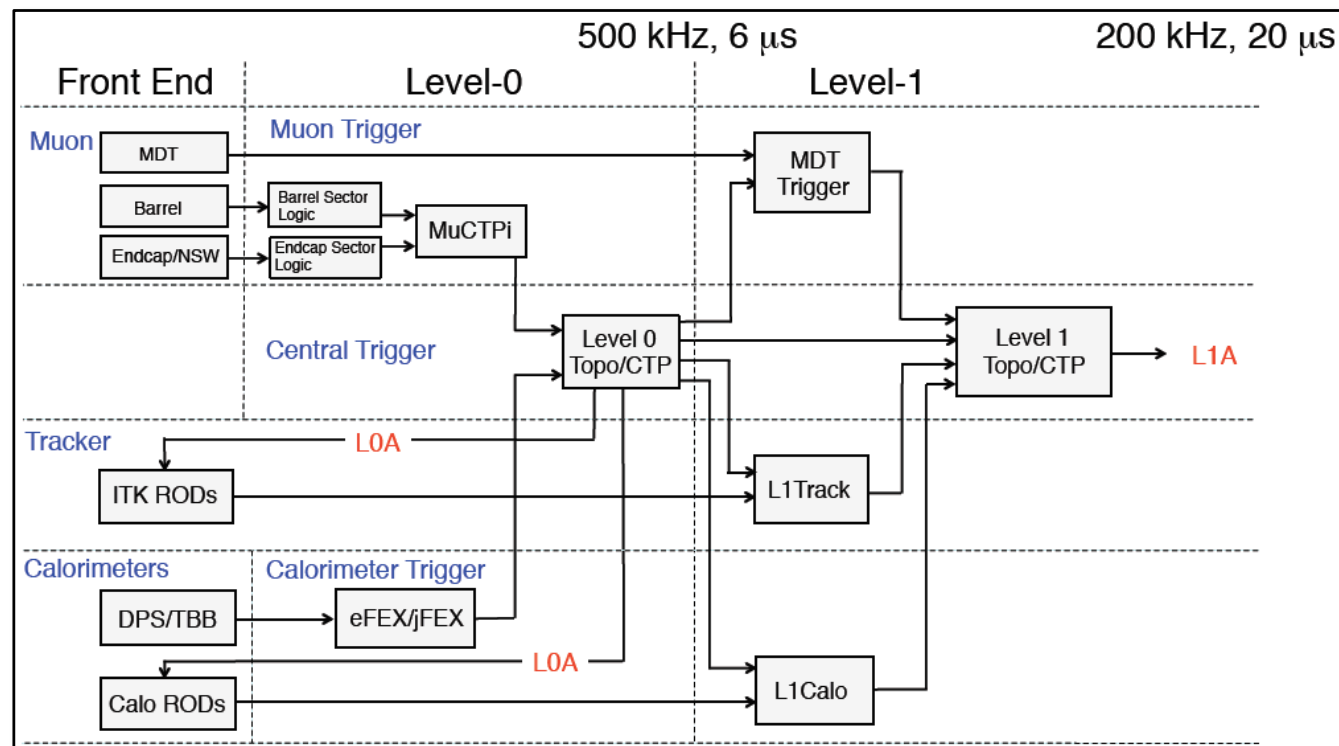



- Top priorities for the energy frontier in the next two decades:
 - Study the 125GeV Higgs and investigate the dynamics of EWSB
 - Explore thoroughly the multi-TeV scale
 - This exploration has only just started!
 - Strong motivations that new physics must appear at the \sim TeV scale!
- The HL-LHC(3000) programme is unique in addressing both of these priorities in \sim 2024-2035
 - As well as studying and characterising any new physics that might be discovered in the 13-14TeV runs before 2024
- Intense R&D ongoing, both for upgrading the LHC so that it can deliver 3000fb⁻¹, and for the detectors so that they can cope with and profit from the delivered luminosity!



- ECFA HL-LHC workshop in Aix-Les-Baines
- Review of LHC & Injector Upgrade Plans Workshop (RLIUP)
- RLIUP summary session



Back up slides

Update of the European Strategy for Particle Physics

High-priority large-scale scientific activities

After careful analysis of many possible large-scale scientific activities requiring significant resources, sizeable collaborations and sustained commitment, the following four activities have been identified as carrying the highest priority.

c) The discovery of the Higgs boson is the start of a major programme of work to measure this particle's properties with the highest possible precision for testing the validity of the Standard Model and to search for further new physics at the energy frontier. The LHC is in a unique position to pursue this programme.

Europe's top priority should be the exploitation of the full potential of the LHC, including the high-luminosity upgrade of the machine and detectors with a view to collecting ten times more data than in the initial design, by around 2030. This upgrade programme will also provide further exciting opportunities for the study of flavour physics and the quark-gluon plasma.





$$A(X \rightarrow VV) \sim \left(a_1 M_X^2 g_{\mu\nu} + a_2 (q_1 + q_2)_\mu (q_1 + q_2)_\nu + a_3 \varepsilon_{\mu\nu\alpha\beta} q_1^\alpha q_2^\beta \right) \varepsilon_1^{*\mu} \varepsilon_2^{*\nu}$$

- HZZ amplitude can have CP-even & CP-odd terms: CP violation

Significance for various a_3

Integrated Luminosity	Signal (S) and Background (B)	$6 + 6i$	$6i$	$4 + 4i$
100 fb^{-1}	$S = 158; B = 110$	3.0	2.4	2.2
200 fb^{-1}	$S = 316; B = 220$	4.2	3.3	3.1
300 fb^{-1}	$S = 474; B = 330$	5.2	4.1	3.8

3000 fb^{-1} would give sensitivity to much smaller levels of CP violation.



Rare decays: FCNC $t \rightarrow Zq$, $t \rightarrow \gamma q$

In SM, BR $\sim 10^{-12}$

New physics models predict BRs up to $\sim 10^{-4}$

with 3000fb^{-1} sensitivity to BR $\sim 10^{-5}$

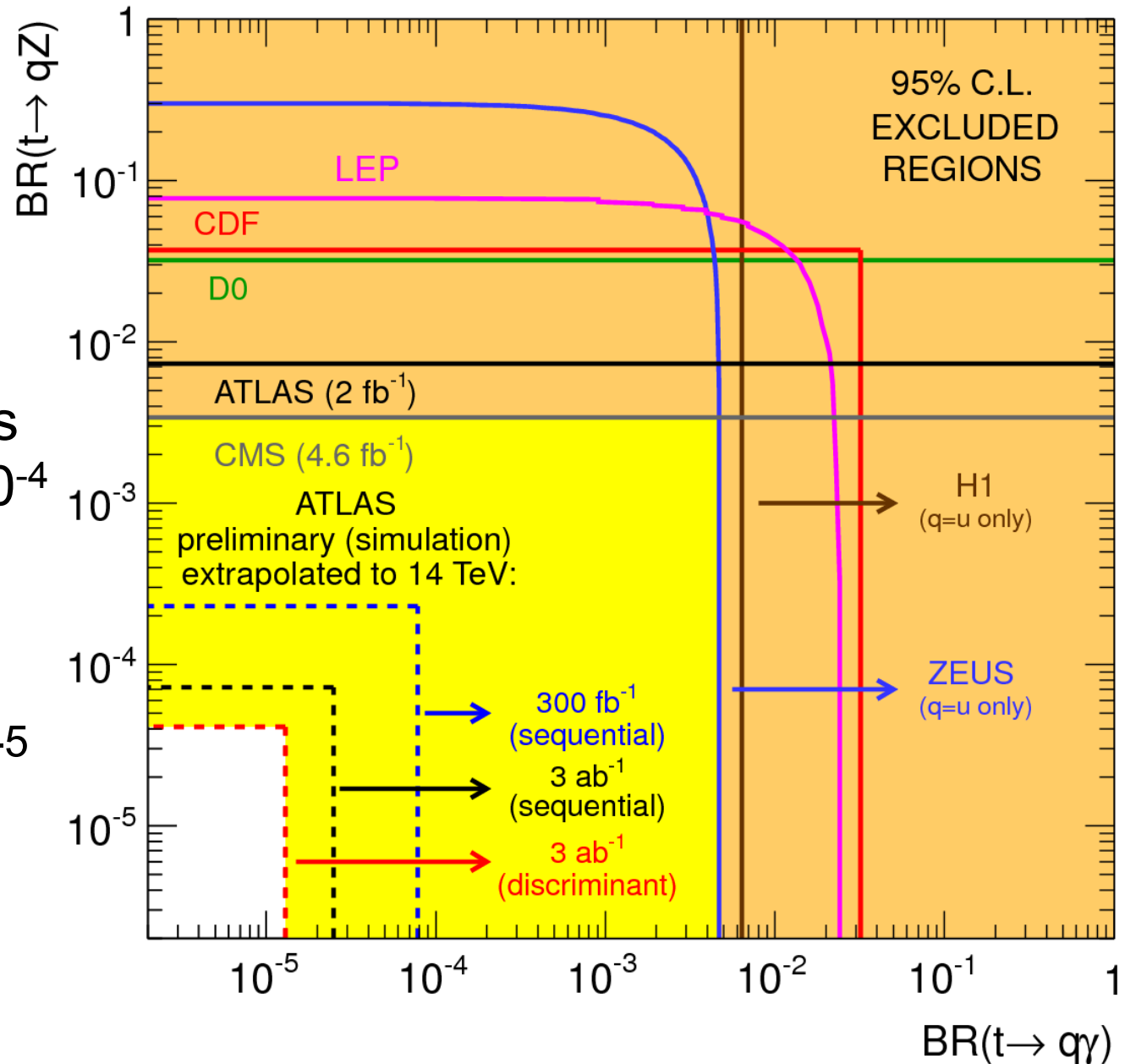

How well should the Higgs couplings be measured ?

Brock/Peskin, Snowmass 2013

Facility	LHC	HL-LHC	ILC500	ILC500-up	ILC1000	ILC1000-up	CLIC	TLEP (4 IPs)
\sqrt{s} (GeV)	14,000	14,000	250/500	250/500	250/500/1000	250/500/1000	350/1400/3000	240/350
$\int \mathcal{L} dt$ (fb $^{-1}$)	300/expt	3000/expt	250+500	1150+1600	250+500+1000	1150+1600+2500	500+1500+2000	10,000+2600
κ_γ	5 – 7%	2 – 5%	8.3%	4.4%	3.8%	2.3%	-/5.5/<5.5%	1.45%
κ_g	6 – 8%	3 – 5%	2.0%	1.1%	1.1%	0.67%	3.6/0.79/0.56%	0.79%
κ_W	4 – 6%	2 – 5%	0.39%	0.21%	0.21%	0.13%	1.5/0.15/0.11%	0.10%
κ_Z	4 – 6%	2 – 4%	0.49%	0.24%	0.44%	0.22%	0.49/0.33/0.24%	0.05%
κ_ℓ	6 – 8%	2 – 5%	1.9%	0.98%	1.3%	0.72%	3.5/1.4/<1.3%	0.51%
κ_d	10 – 13%	4 – 7%	0.93%	0.51%	0.51%	0.31%	1.7/0.32/0.19%	0.39%
κ_u	14 – 15%	7 – 10%	2.5%	1.3%	1.3%	0.76%	3.1/1.0/0.7%	0.69%

Scenarios with no new particles observable at LHC

HL-LHC (3000 fb $^{-1}$): percent level
 → some sensitivity to physics beyond SM

ILC/TLEP: sub-percent level
 Note: hard to believe that New Physics will manifest itself through tiny effects on Higgs couplings and nothing else ...unless very heavy (but then how to interpret the observed deviations ?)

	κ_V	κ_b	κ_γ
Singlet Mixing	~ 6%	~ 6%	~ 6%
2HDM	~ 1%	~ 10%	~ 1%
Decoupling MSSM	~ -0.0013%	~ 1.6%	< 1.5%
Composite	~ -3%	~ -(3 – 9)%	~ -9%
Top Partner	~ -2%	~ -2%	~ -3%

LHC schedule beyond LS1

Only EYETS (19 weeks) (no Linac4 connection during Run2)

LS2 starting in 2018 (July) 18 months + 3months BC (Beam Commissioning)

LS3 LHC: starting in 2023 => 30 months + 3 BC
 injectors: in 2024 => 13 months + 3 BC

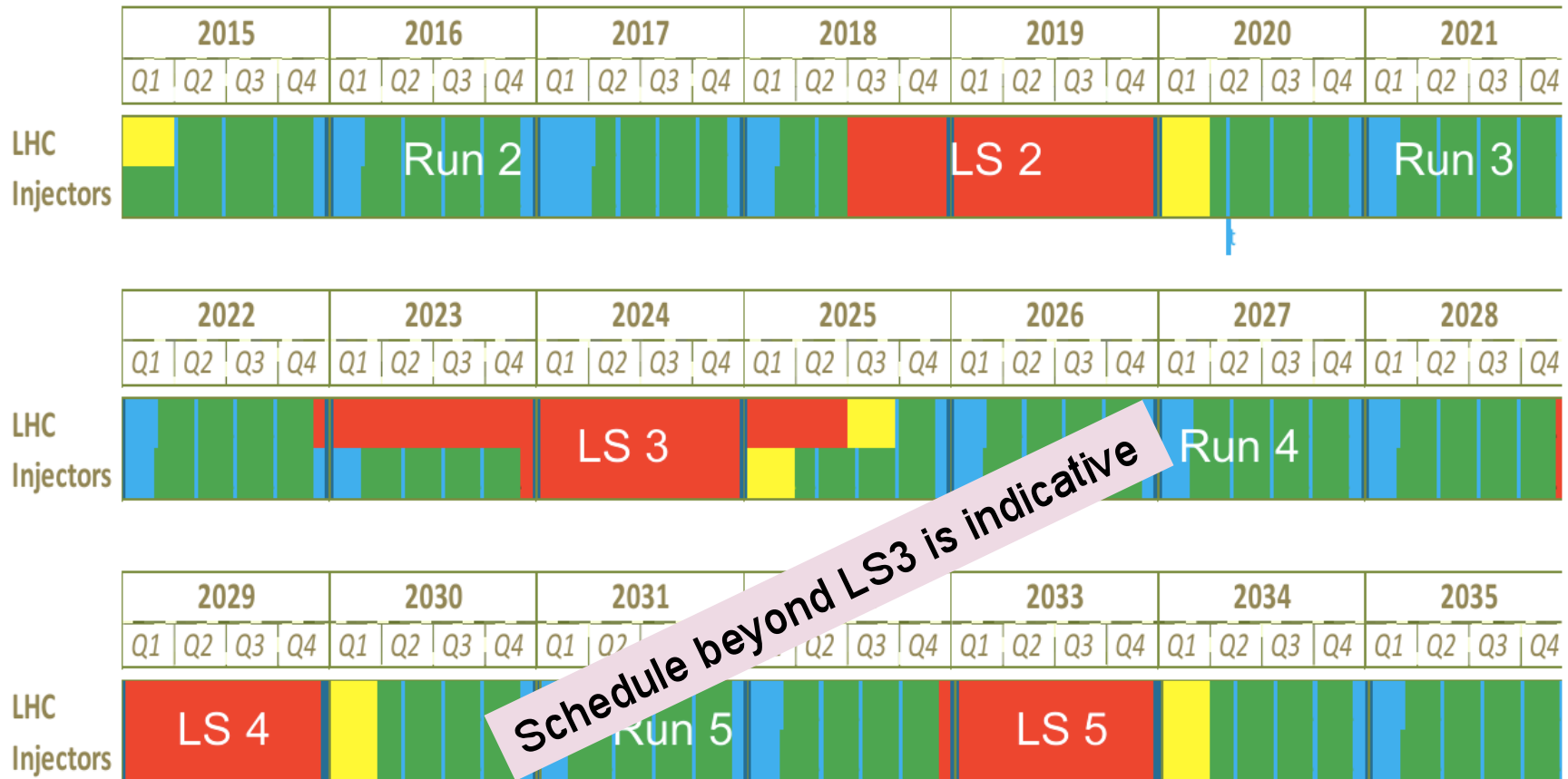

Schedule beyond LS3 is indicative





Luminosity targets till ~2035

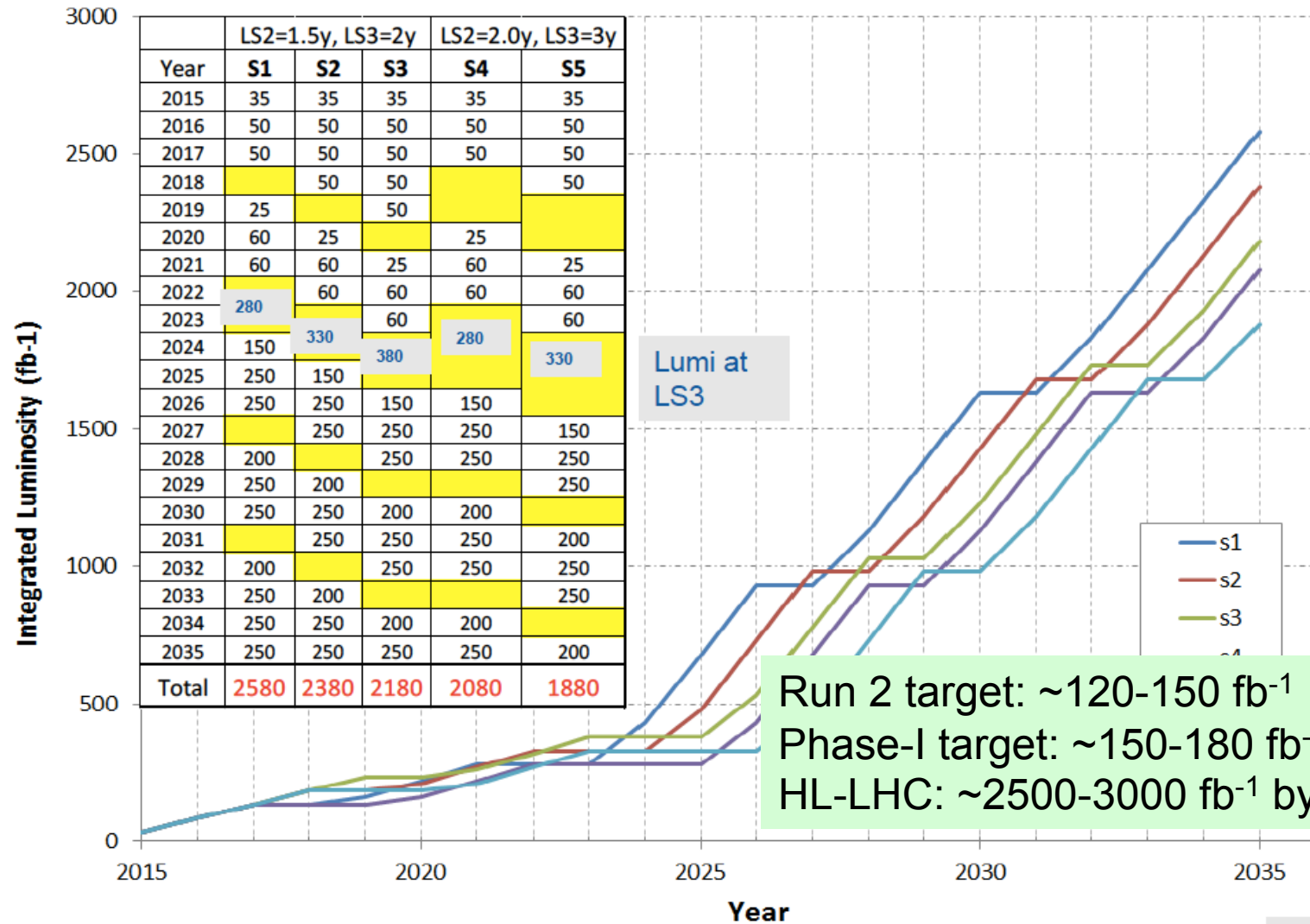

Run 2 target: ~120-150 fb⁻¹
 Phase-I target: ~150-180 fb⁻¹
 HL-LHC: ~2500-3000 fb⁻¹ by ~2035



- Studies initiated for the European Strategy process in 2012-13
 - Boosted by the Higgs discovery in summer 2012
 - Accelerated thanks to the LHC shutdown in 2013-14
- Projections use conservative assumptions about detector performance at HL-LHC and the evolution of systematic uncertainties
 - Impressive progress in minimizing the impact of pile-up during 2012
 - In 2012, $\langle\mu\rangle$ up to ~ 35 ; extrapolation to $\langle\mu\rangle\sim 140$ not huge
- ATLAS performed generator-level studies, applying resolution and efficiency parameterisation functions for the HL-LHC conditions
 - With realistic/conservative assumptions for the effects of pile-up
 - E.g. full sim. studies of b-tagging with tracker upgrade now show better performance
- CMS extrapolate current results with two different assumptions
 - (1) Pessimistic: experimental and theory systematics as of today
 - (2) Optimistic: experimental systematics scale as $1/\sqrt{L}$, theory systematics halved

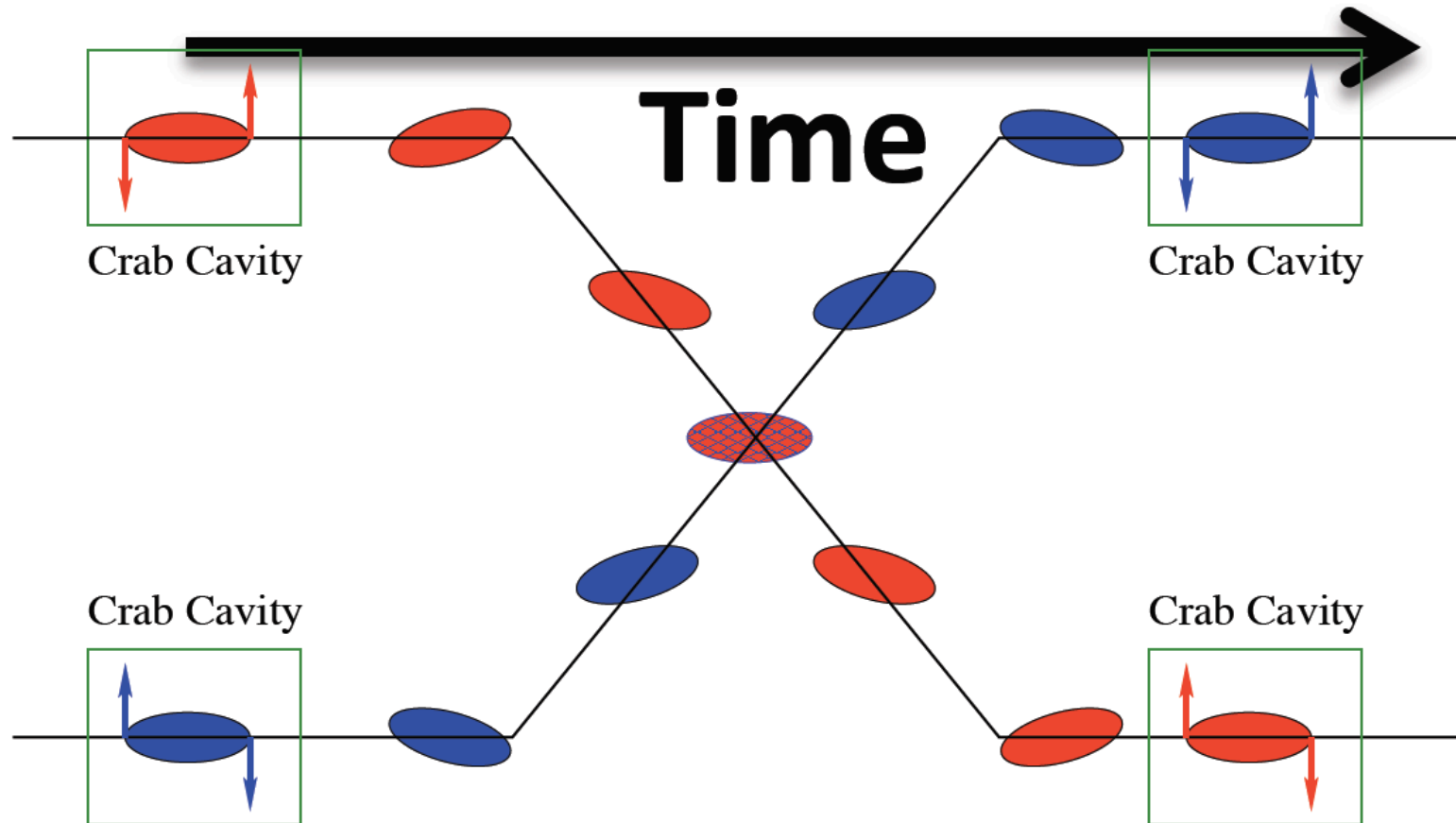

First operated successfully at KEKB, but never at a p-p machine