

# An Energy Spectrometer for the International Linear Collider

Reasons, challenges, test experiments and progress

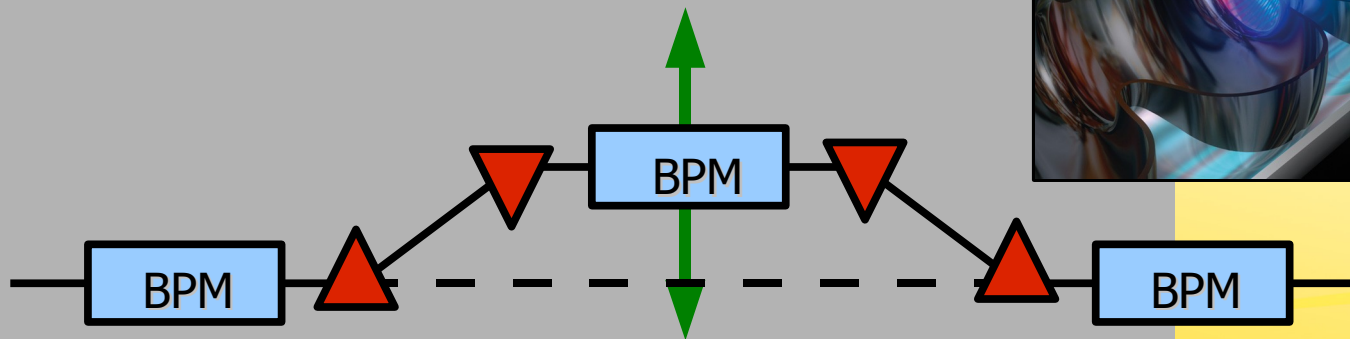

Bino Maiheu  
University College London  
bino@hep.ucl.ac.uk

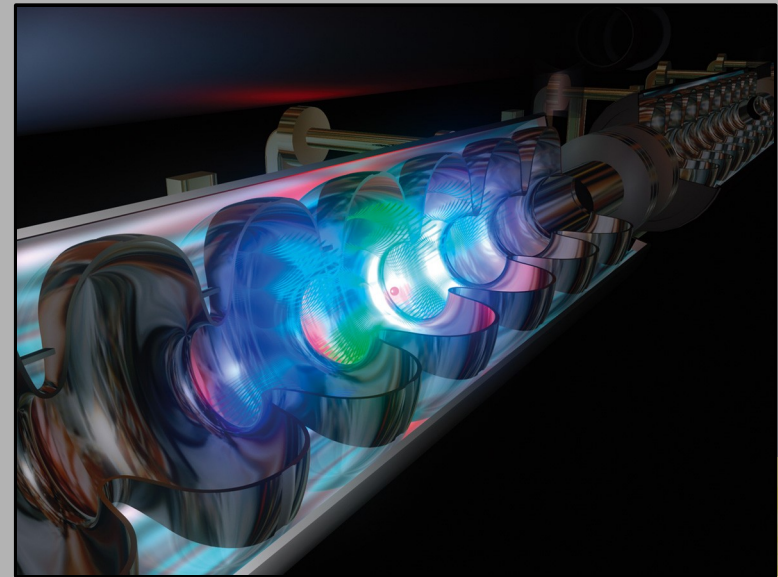
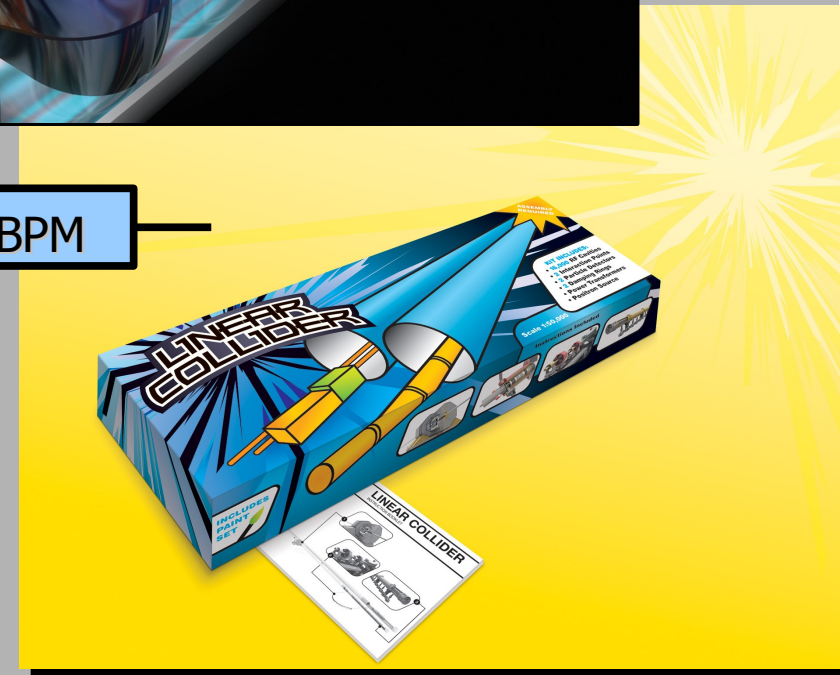

# Seminar Outline

- Why build the linear collider, and what is it actually ?
- How does such a linear collider look like ?
- Importance of the beam energy measurement...
- Development of a magnetic chicane spectrometer based upon high resolution Beam Position Monitors (**BPM**)
  - Principles...
  - High resolution cavity beam position monitors...
- Test experiments, End Station A at SLAC...
- Outlook for our project...

# What is the ILC and why build it ?

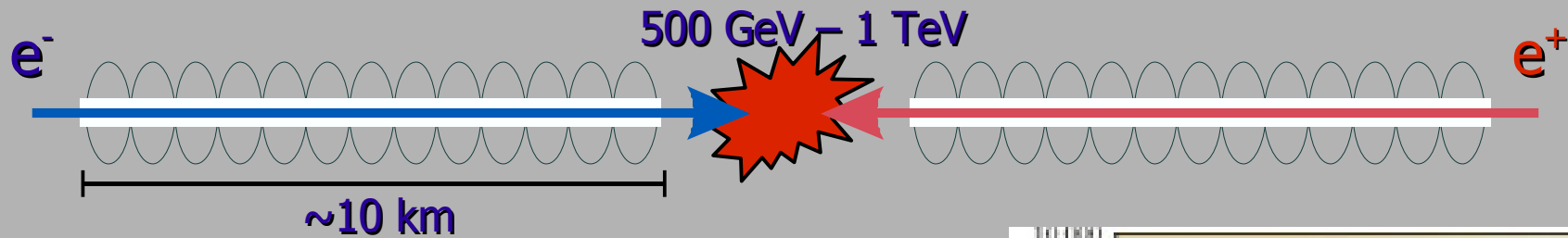

- Proposed  $\sim 30$  km long **linear**  $e^+e^-$  collider
- CM energy up to **1 TeV**
- **International...** obviously
- targeted completion around 2020

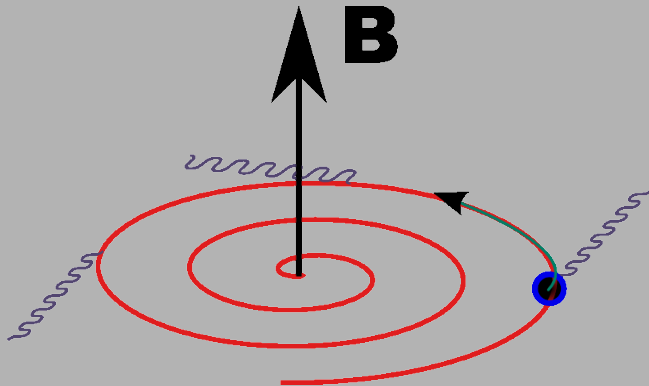

costs  $\sim P_{RF}$   
 $\Delta E_{turn} \sim E^4 / \rho$

- $e^+e^-$  : colliding elementary particles : **clean** !
- Precision measurements from discoveries made at hadron machines ( eg. LHC )

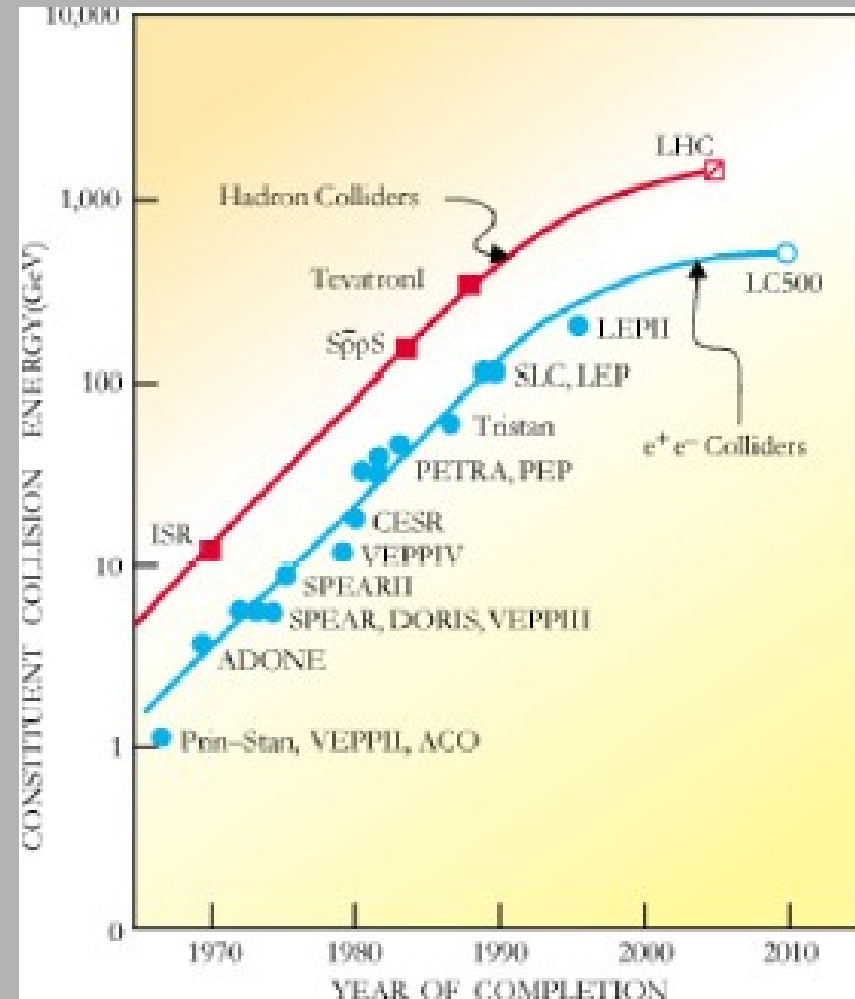

# Physics case for the ILC

- Standard model physics
  - Precision electroweak and QCD measurements
  - Top quark threshold, mass, width, yukawa coupling
  - Properties of (a) Higgs particle(s)
  - Giga Z, etc...
- Physics beyond the standard model.
- What is awaiting us at the **Terascale** ?
- SUSY, GUT, extra dimensions, dark matter, etc...

The energy scale and the physics program push present day technology to the limit...

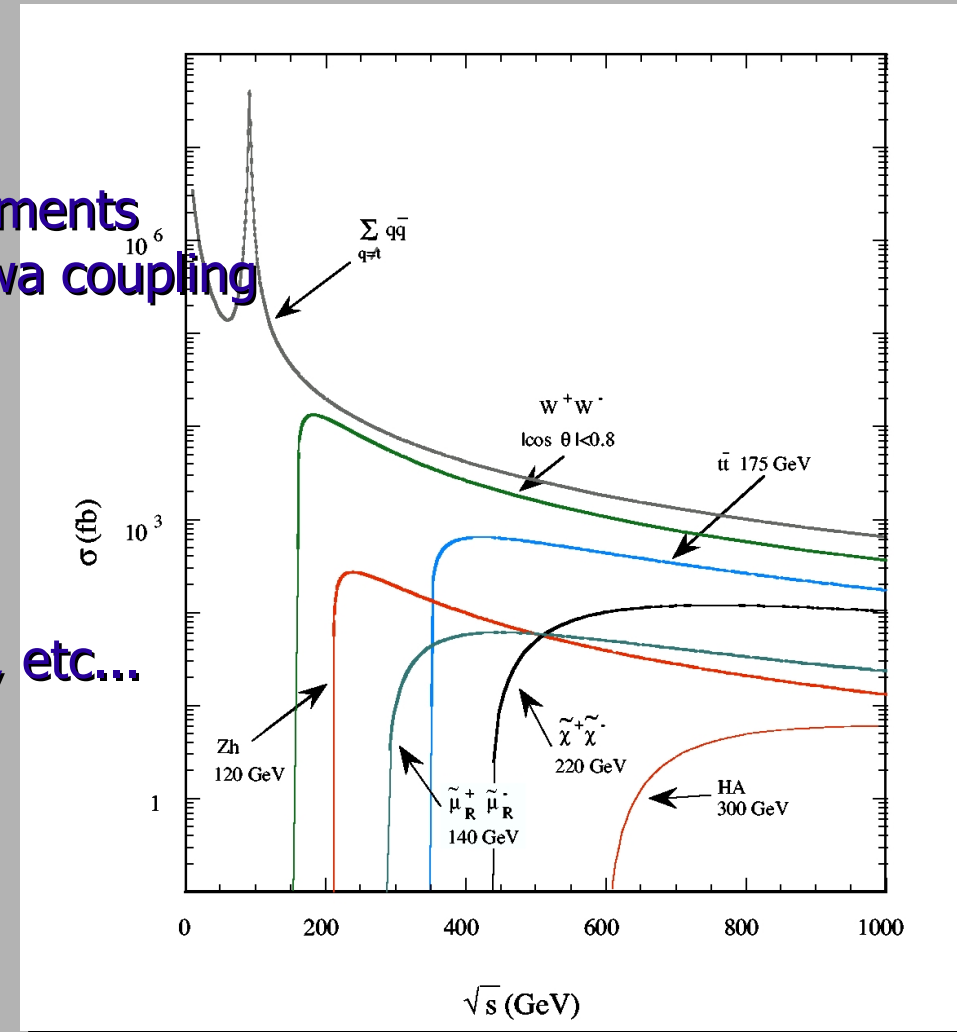

→ Lot of **R&D programs** actively trying to make the ILC feasible both on the **detector** and **accelerator** side

# Proposed layout of the ILC... I hope :)

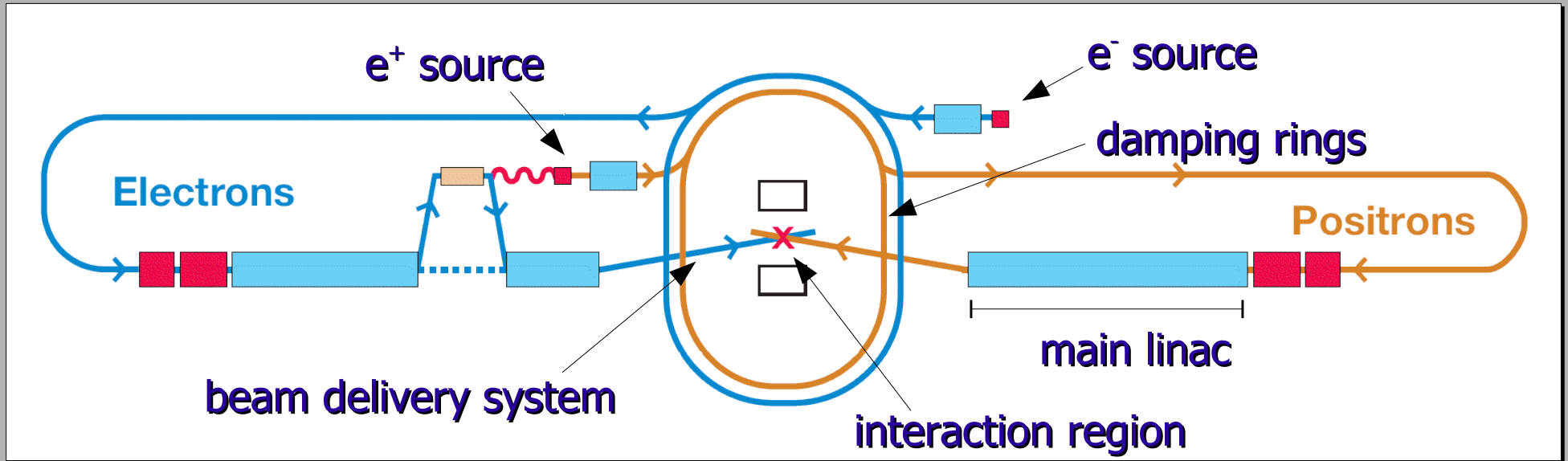

- Particle sources
  - electrons : pulsed laser
  - positrons : 150 GeV electrons through undulator
- Damping rings
  - reduce transverse beam size (emittance), establish bunch train structure, 2625/pulse
- Main linac :
  - Accelerate beam from about 5 GeV to 500 GeV, super conducting RF cavities
- **Beam delivery system** : beam diagnostics, focussing, collimation
- Interaction region : final focussing and beams into collision.
- Extraction line : safely dispose of heavily distorted beam + diagnostics
- 1 Experimental hall, 2 detectors in push-pull and 14 mrad crossing angle



# Some of many challenges...

- Average accelerating gradient  $\sim 31.5$  MeV/m
- Final focussing needed to get  $2 \times 10^{34}/\text{cm}^2/\text{s}$ 
  - $\text{Lumi} \sim f_{\text{rep}} / \sigma_x \sigma_y$
  - $f_{\text{rep}} = 40$  kHz (LEP), = 5 Hz (ILC)
  - Need vertical beam size of 5 nm + measure it !!  
( compare to  $0.0003 \times 10^{34}/\text{cm}^2/\text{s}$  and 500 nm beam size for SLC )
- Infrastructure :
  - 31 km main tunnel + 6.7 km damping ring
  - 230 MW power consumption
- Beam dump.. dispose of 18MW of beam power  
( compare to 0.04 MW for SLC )
- Beam Delivery System ( e.g. energy measurement):
  - you only get 1 go, no averaging ( LEP )

The ILC physics program requires an energy measurement uncertainty of  $dE/E = 10^{-4}$

Let's have a look at the top quark to understand why...

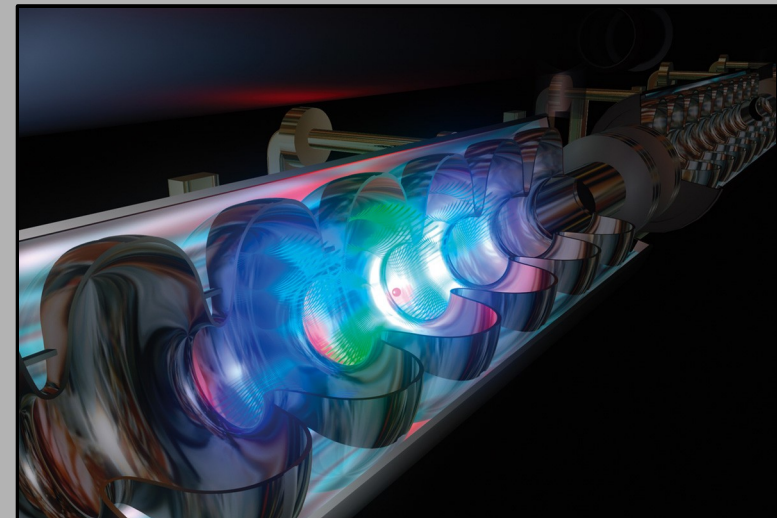

# Physics case for good energy measurement

## Case study : the top quark

- Top quark : large decay width  $\rightarrow$  pQCD !!
- ILC = top quark factory, QCD precision tests
- Better precision on the top mass constrains Higgs & SUSY parameters better

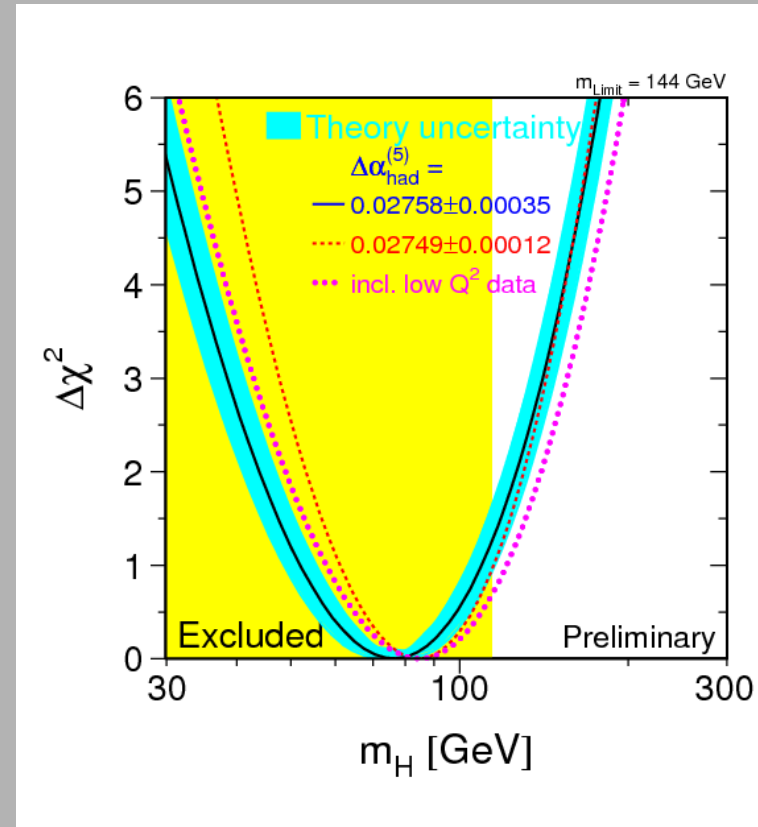
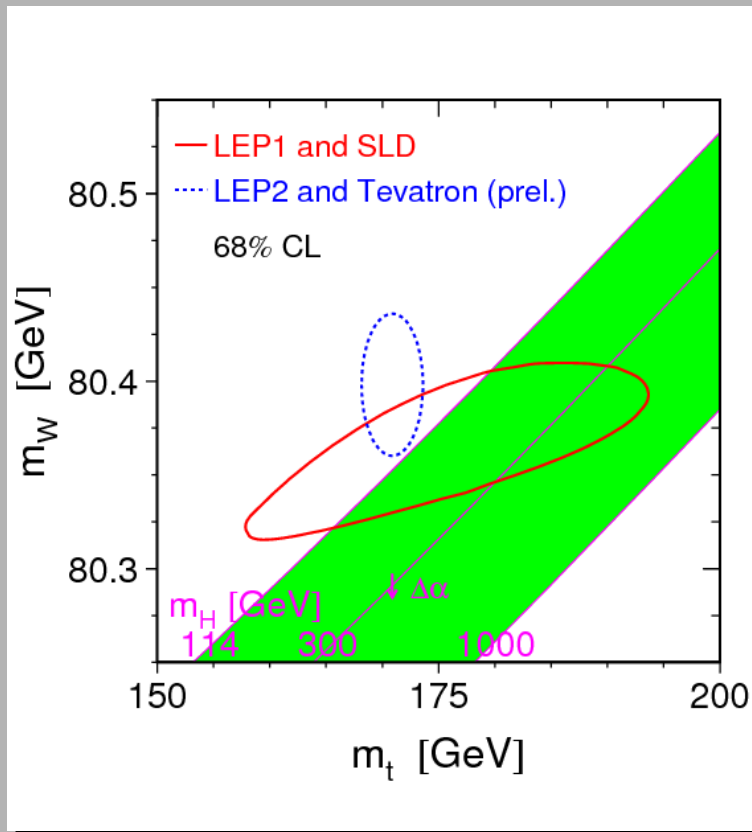

Beam energy determination is largest contribution of systematics...

# Influence of energy spread on top threshold...

## Luminosity spectrum $dL/dE$

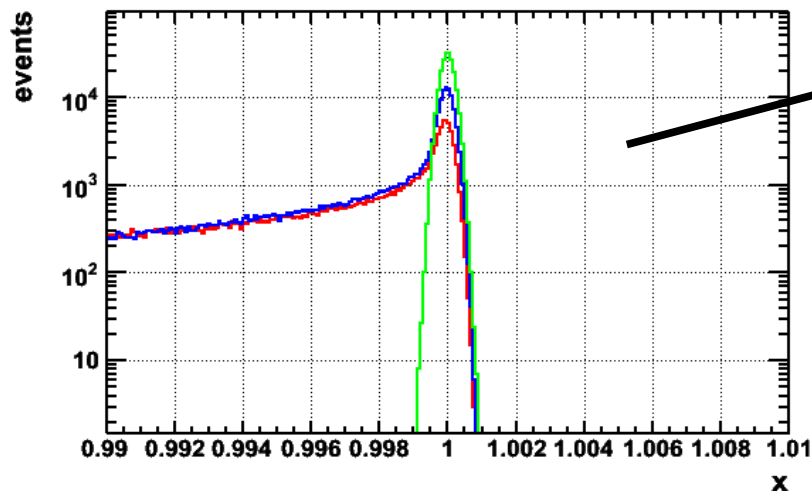
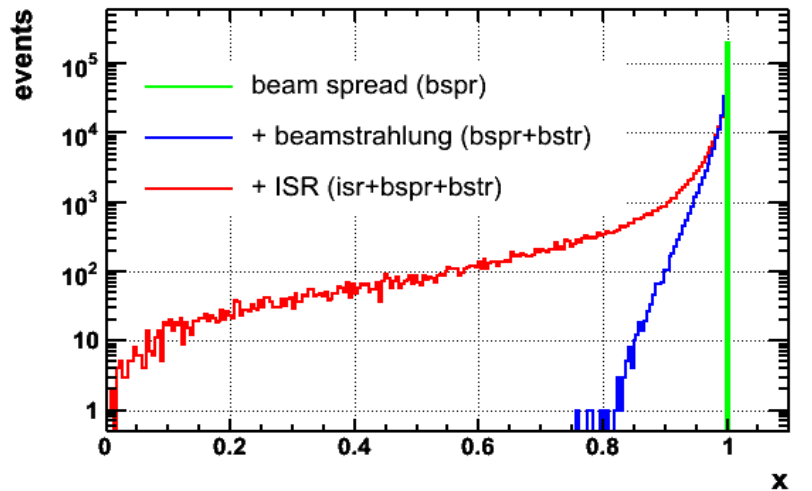

Energy at collision is **not delta function !!**

- Inherent energy spread
- Beamstrahlung
- Initial state radiation

## Top quark mass scan

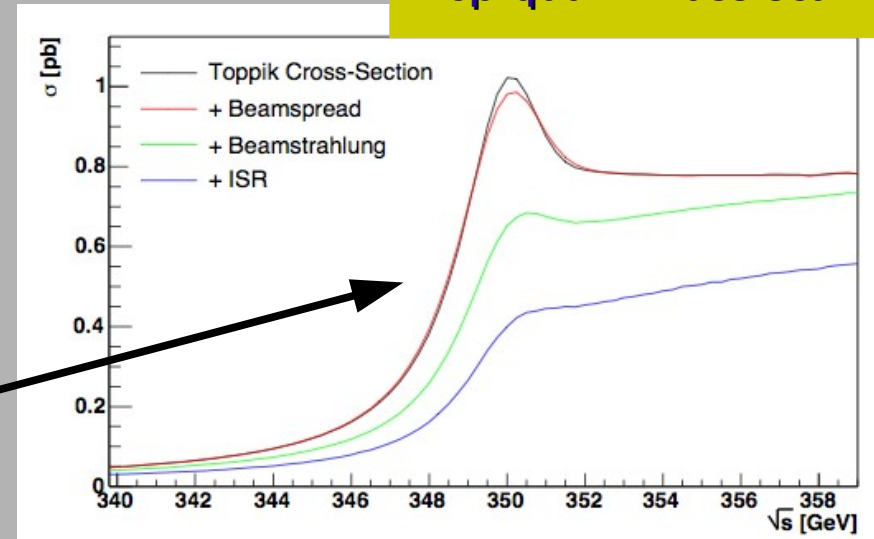

Uncertainty on beam energy measurement contributes directly to the uncertainty on the ILC physics output...

➔ Magnetic chicane with high resolution BPMs



# BPM Spectrometry

$$E \sim \int B \cdot dl / \Theta$$

Study & design magnetic chicane for beam energy measurement using Beam Position Monitors (BPMs) :

so... reduce energy measurement to beam position measurement

Royal Holloway University London: S. Boogert

Cambridge : M. Slater, M. Thomson and D. Ward

University College London: F. Gournaris, A. Lyapin, B. Maiheu, S. Malton, D. Miller and M. Wing

Different aspects of the project...

(putting the I in ILC :)

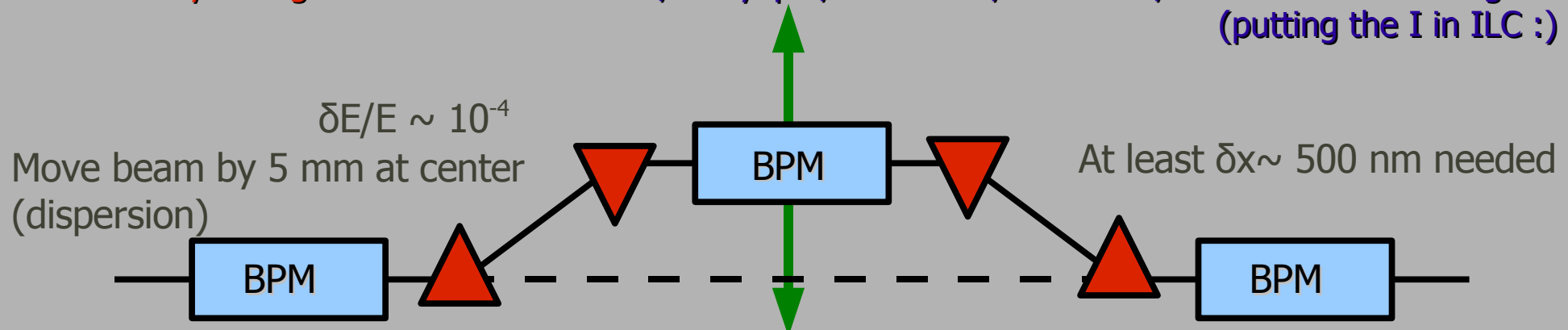

**NanoBPM@ATF (KEK)** : test **resolution**, try different **analysis methods**, BPM stability tests, **multi bunch** operation, advanced electronics techniques, **inclination** of beam in BPMs.

-> spectrometer aspects of BPMs can be tested

**ESA@SLAC** : test **stability** and **operational issues** with a full implementation of **4 magnet chicane** and 3 BPM stations

-> test of real chicane prototype

will talk about ESA later on...

# What kind of BPMs to use ?

- Beam position monitors essential diagnostic for accelerators
  - Beam orbit in accelerator : steering, alignment, energy
  - Specialist applications such as energy spectrometer
- Many different varieties exist
  - Operate via electromagnetic interaction with structure placed around the beam
  - Button (1 mm – 10  $\mu\text{m}$ )
  - Stripline (100  $\mu\text{m}$  - 1  $\mu\text{m}$ )
  - Resonant cavity (1  $\mu\text{m}$  - 20 nm)
  - ...

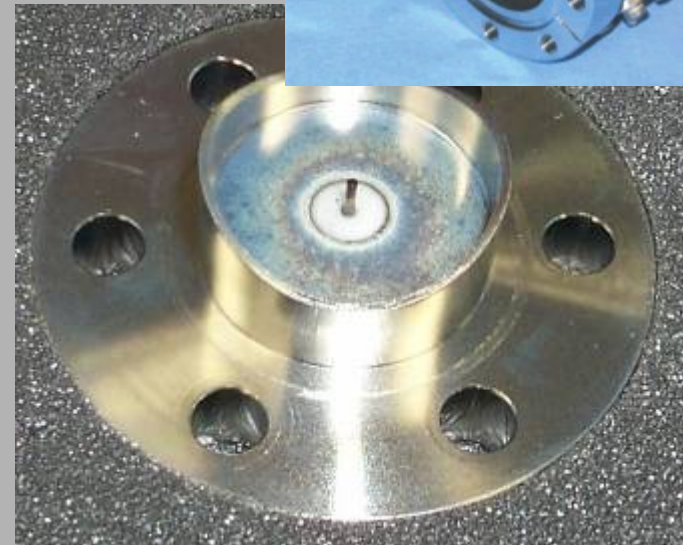
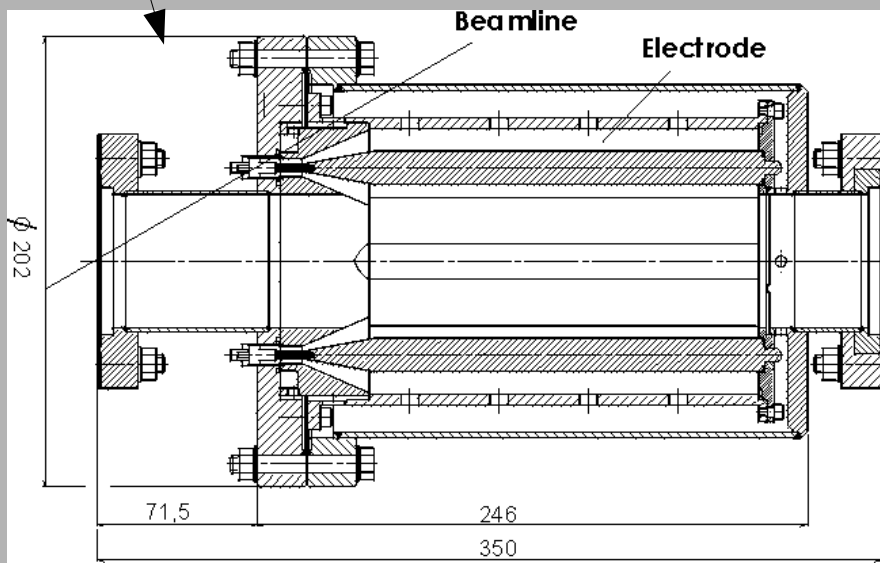
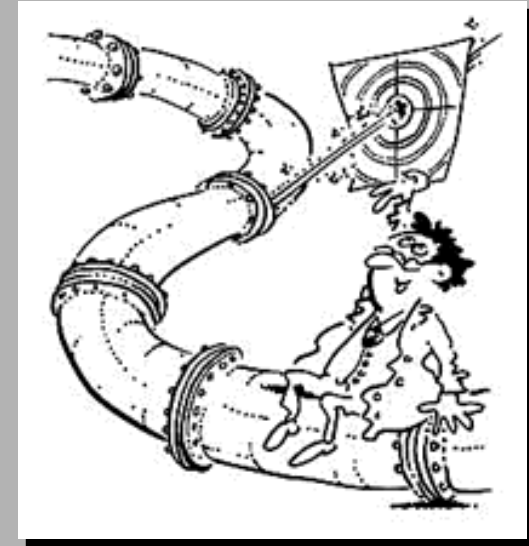

# Introducing resonant cavity beam position monitors...

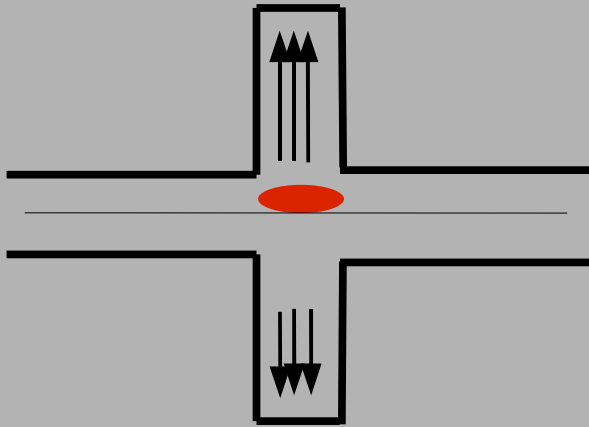

Solution of the EM wave equations taking into account the boundary conditions of the conducting walls leads to certain eigenmodes of cavity excitation by the beam...

For the interested :) :

$$E_z = C J_1 \left( \frac{j_{11} r}{R} \right) \cos \phi e^{i\omega t}$$

$$H_r = -iC \frac{\omega \epsilon_0 R^2}{j_{11}^2} \frac{J_1 \left( \frac{j_{11} r}{R} \right)}{r} \sin \phi e^{i\omega t}$$

$$H_\phi = -iC \frac{\omega \epsilon_0 R}{j_{11}} J_1' \left( \frac{j_{11} r}{R} \right) \cos \phi e^{i\omega t}$$

Configuration of first dipole mode : TM<sub>110</sub>

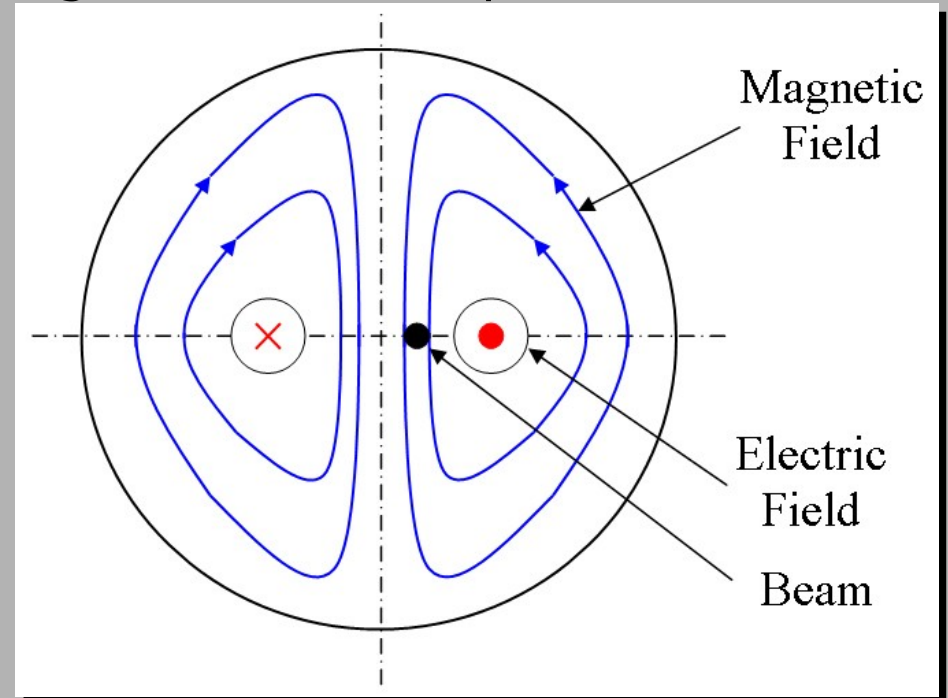

Excitation voltage for TM<sub>110</sub> mode :

$$V_{ex} = E_0 T_{tr} L r / a$$

Offset w.r.t. electrical center

Total electrical field ( bunch charge )

# Of course in real life...

... it's a little bit more complicated... as usual :)

- Accurate **geometrical design** of cavity and manufacturing of cavity is critical
  - Cavity size determines frequency
  - Positioning of antennae to couple out the RF power ( typically couple of GHz )
- Dipole mode depends on :
  - bunch charge
  - beam offset
  - but **also beam tilt**
- need reference cavity :
  - monopole mode TM<sub>010</sub>
  - sensitive to charge only

Prototype reference cavity,  
designed by A. Lyapin (UCL)

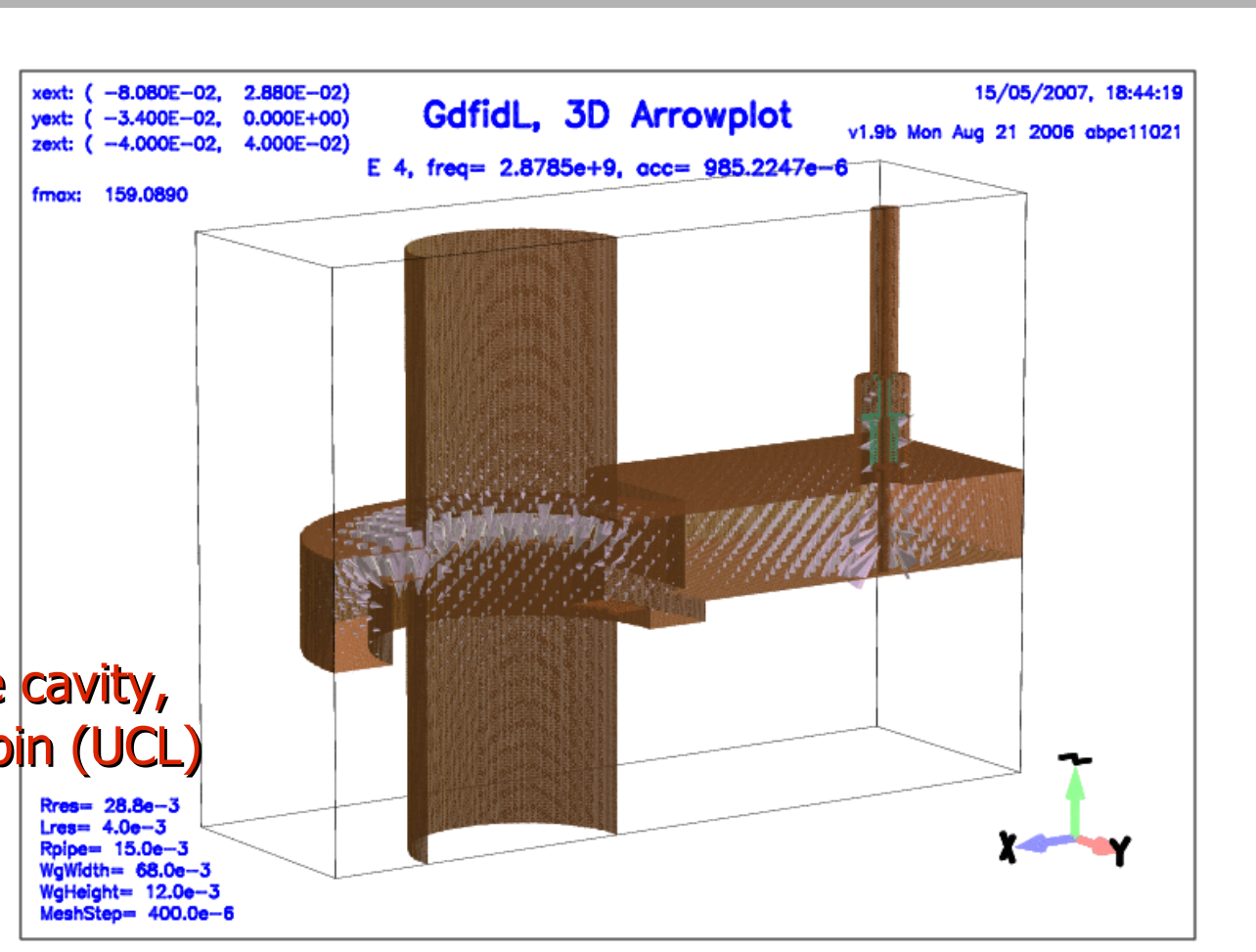



# Handling RF signals from a resonant cavity BPM...

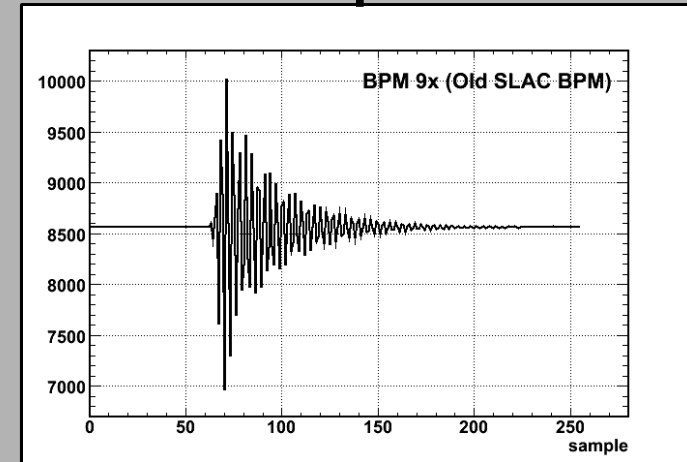
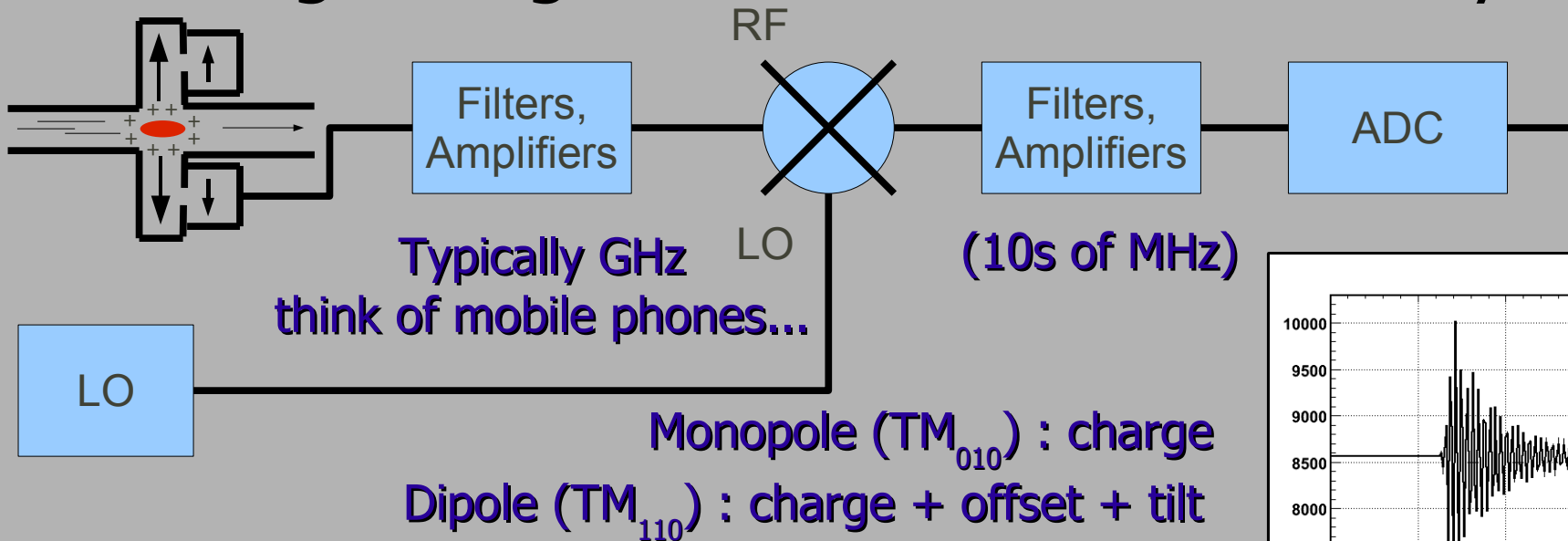

## Determine Amplitude & Phase

- Fit waveform :  $V = V_0 + A e^{-\Gamma(t-t_0)} \sin[\omega(t-t_0) + \phi]$
- Digital Down Conversion (DDC) :
  - Multiply waveform with  $e^{i\omega t}$
  - Filter out  $2\omega$  component
  - Sample waveform at fixed point for linearity  $\rightarrow A, \phi$

## Disentangle charge, offset and tilt :

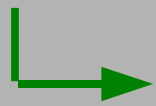

1. Normalize signal to Ref (Q) Cavity
2. IQ rotation ( $\pi/2$  tilt phase difference)
3. Calibrate

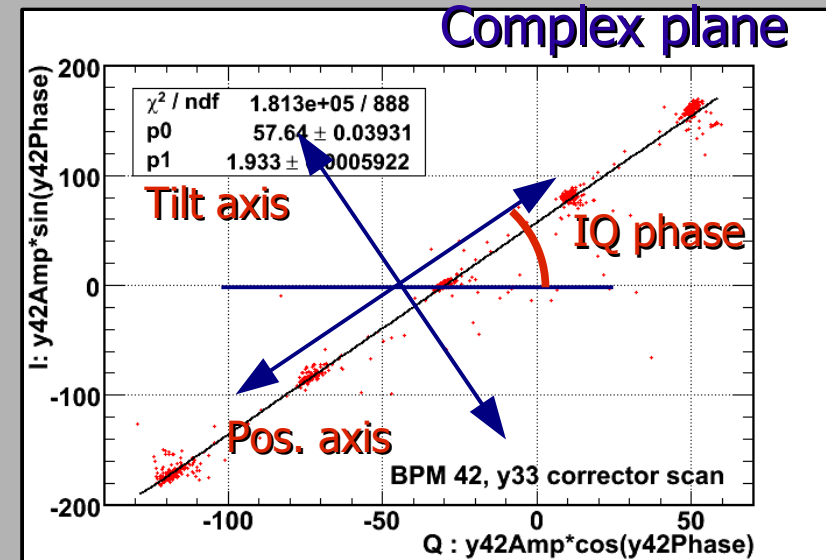



# Some examples of resonant RF cavities...

ILC cold linac prototypes, 2.9 GHz

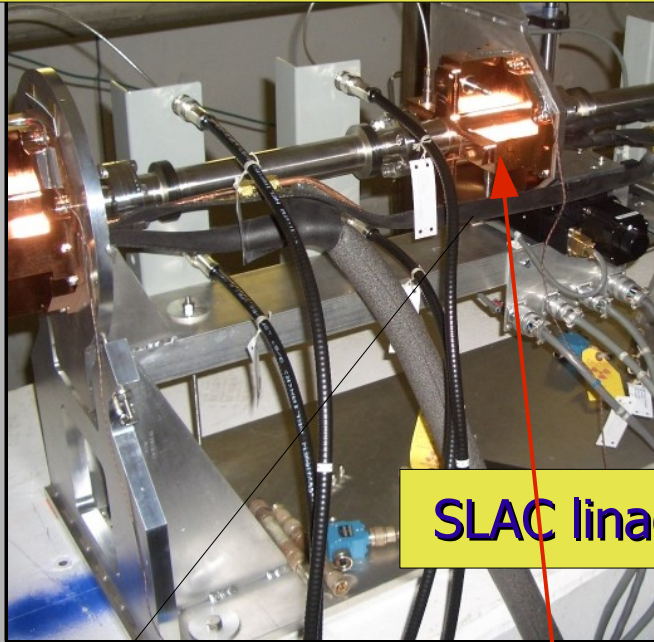

SLAC linac cavity BPMs, 2.9 GHz

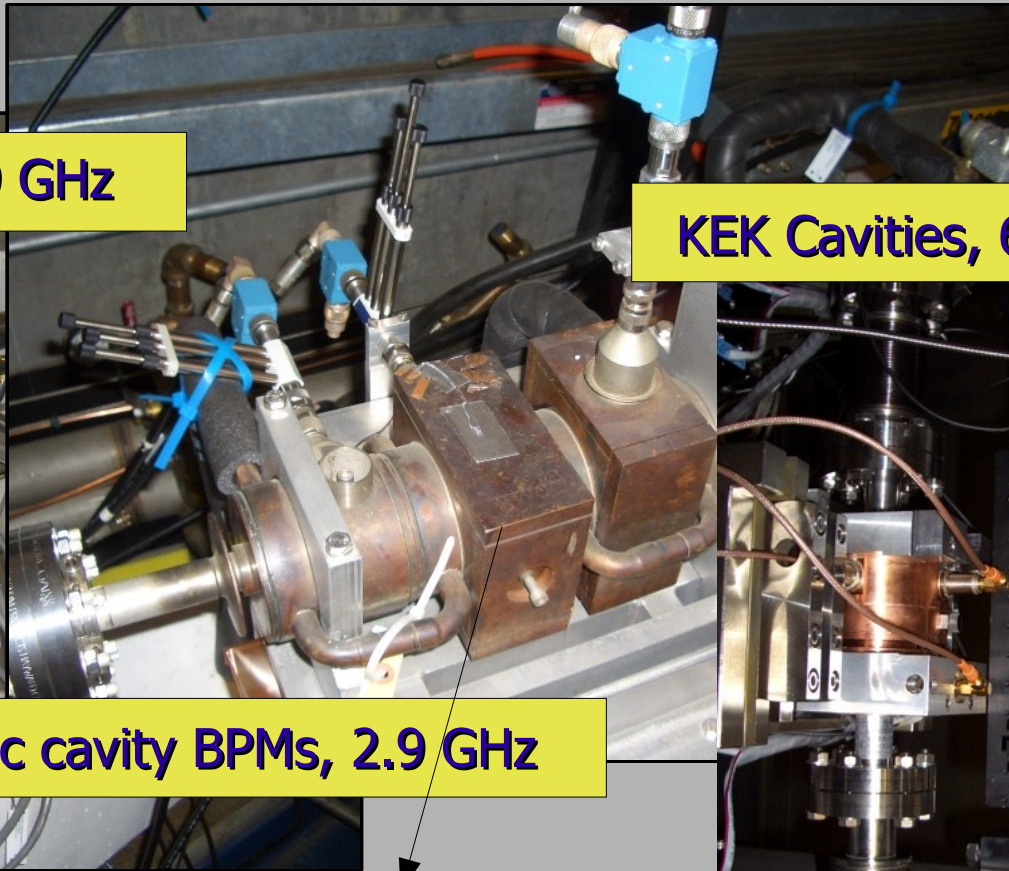

KEK Cavities, 6.4 GHz

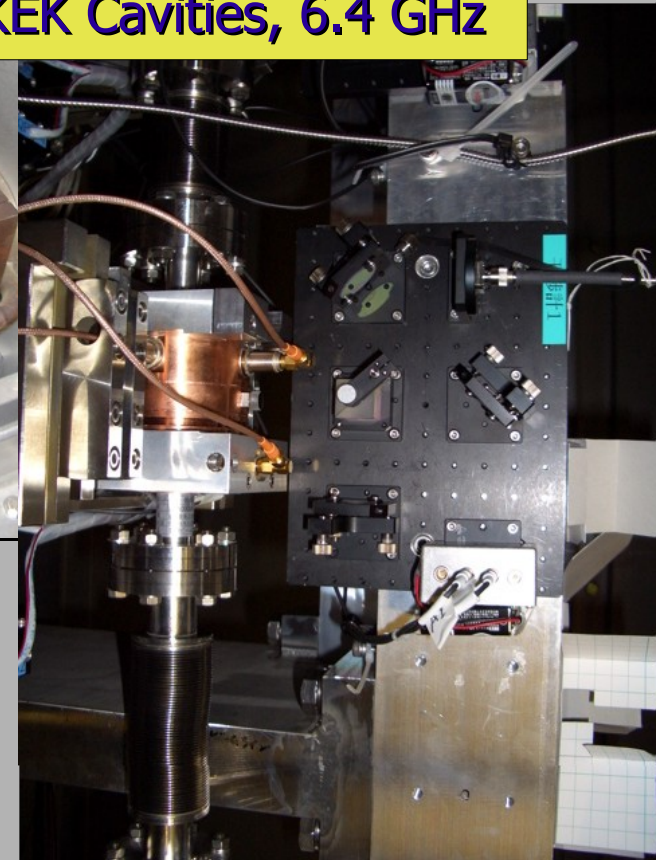

Coupling slot ( antenna )

Rectangular cavity,  
separate X and Y

Pillbox cavity, with X and Y in same physical cavity  
optimised for short ILC bunch spacing ( 300 ns ) and cleaning for use in cold LINAC

Z. Li and C.Adolfson et al.



# What precision can we reach with these BPMs ?

NanoBPM Collaboration: LBNL, LLNL, SLAC, KEK, BINP

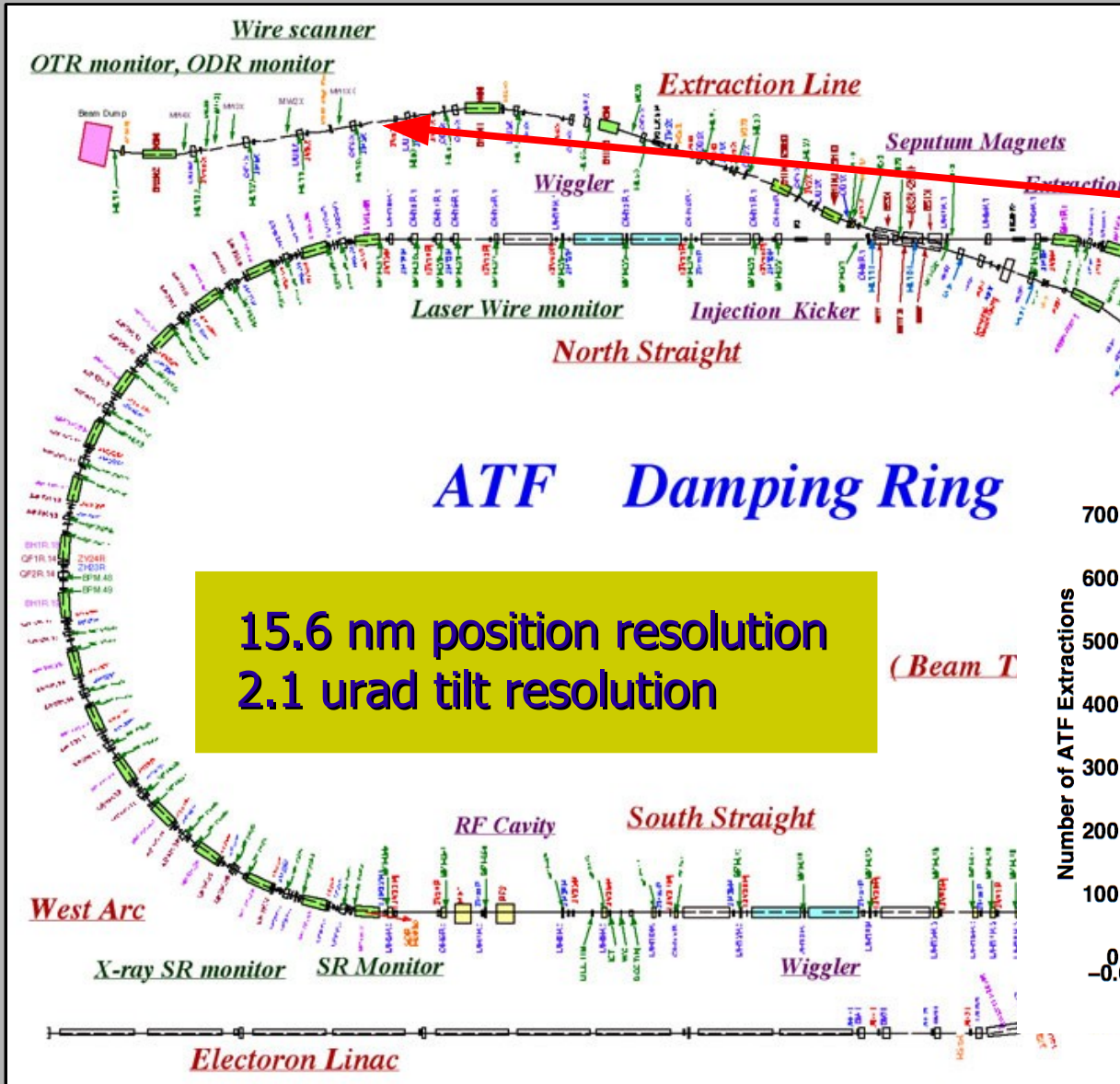
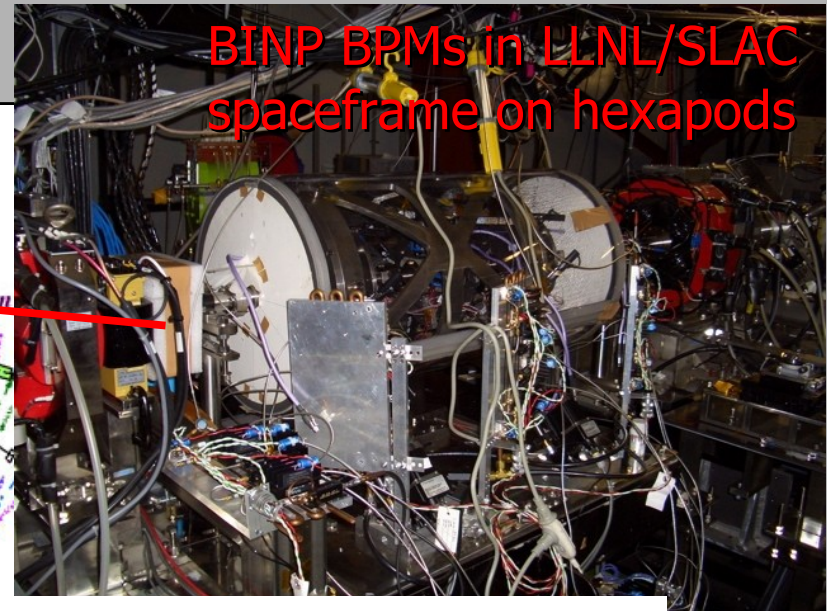

15.6 nm position resolution  
2.1 urad tilt resolution

(Beam T)

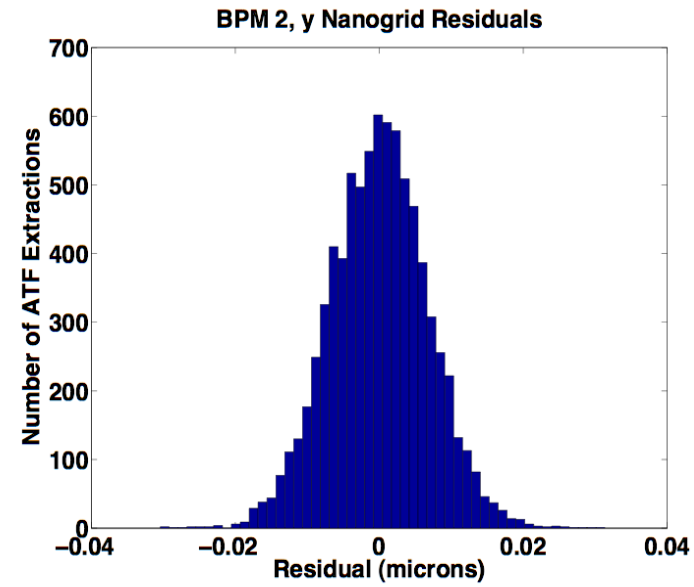

# However, current BPM designs not optimal for ILC purposes...

So far a good ILC spectrometer BPM prototype in itself hasn't been built yet...

- aperture ( machine protection, resolution )
- resolution, stability
- monopole rejection : distortion of decaying waveform
- coupling -> decay time (multi bunch studies)

Our collaboration is developing a new prototype together with processing electronics exactly for this purpose... beam test underway at ESA in SLAC.

Dipole cavity, 2878 MHz

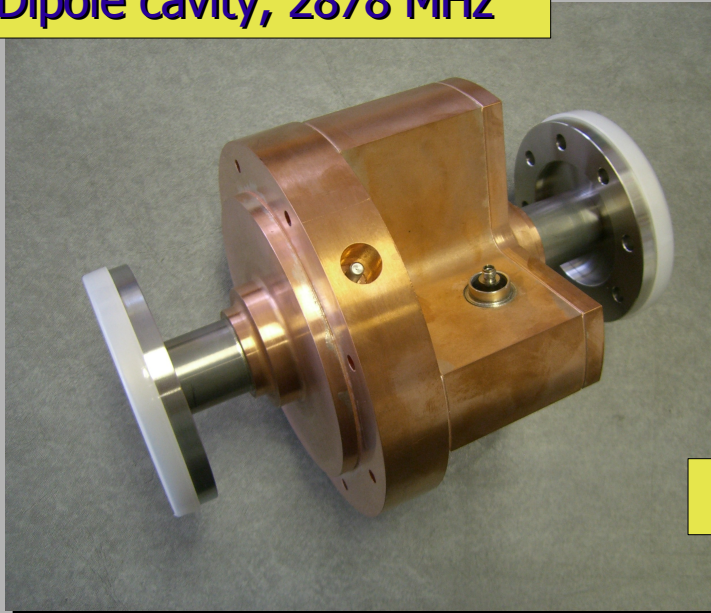

Reference cavity

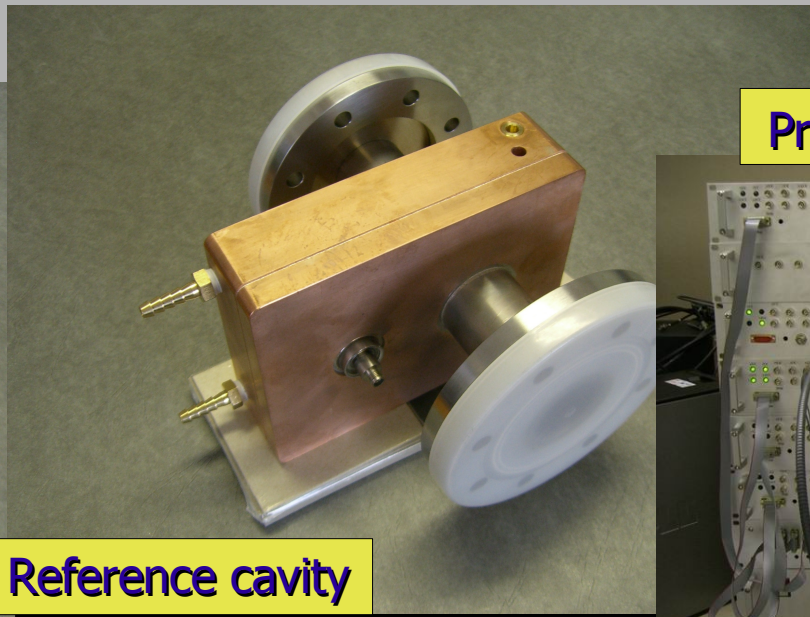

Processor electronics

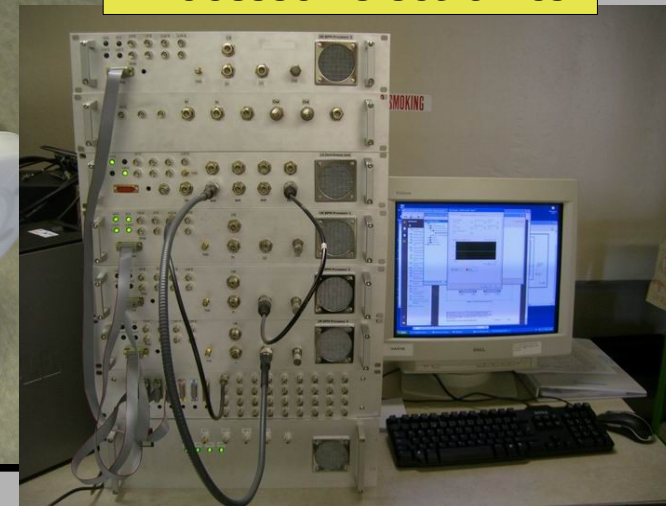



# Putting it all together : T474 at ESA (SLAC)

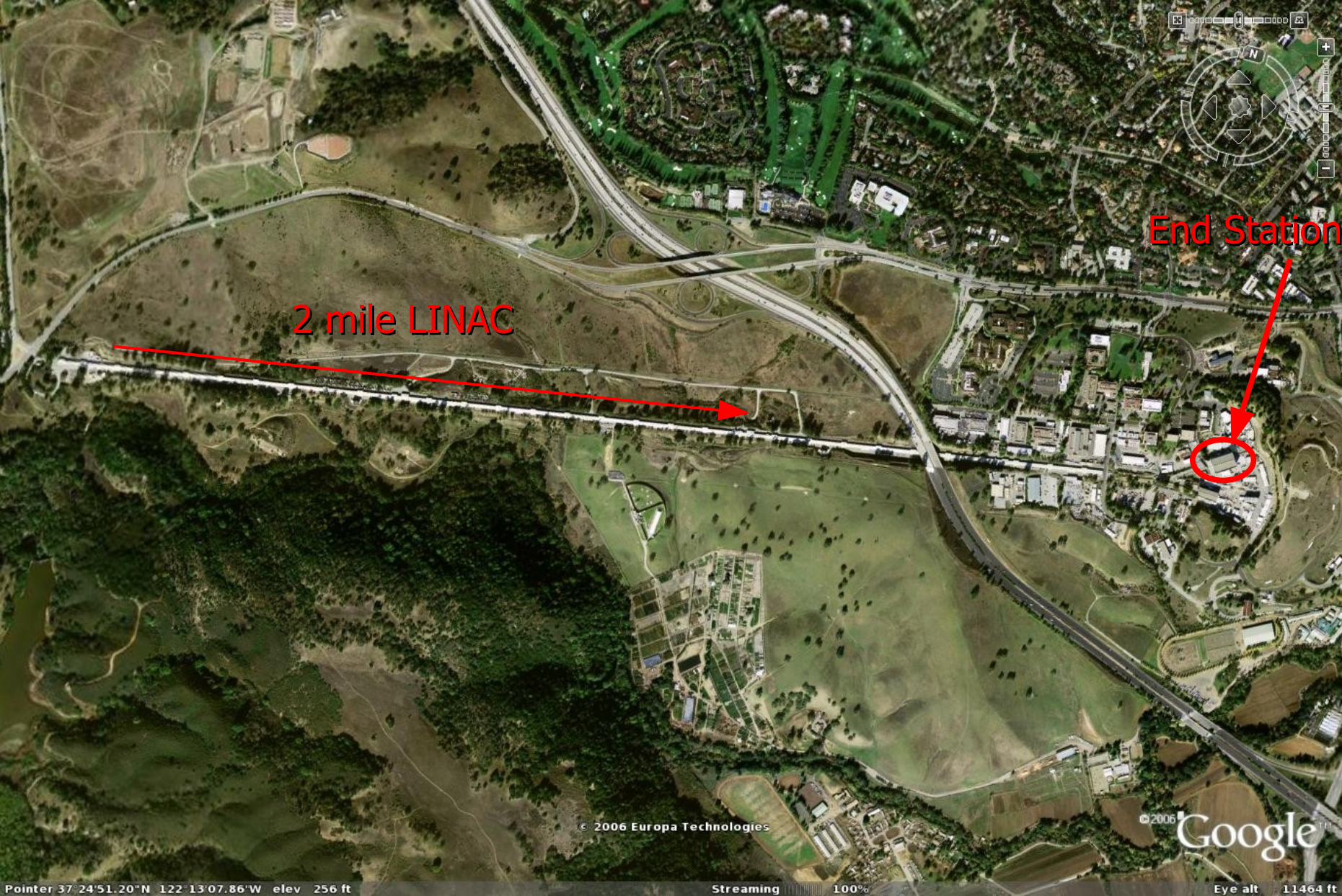



# End Station A at SLAC as ILC testfacility

- ESA is well suited for ILC test experiments, among others :
  - collimator wakefields (N. Watson, S. Molloy et al.)
  - bunch length diagnostics,
  - synchrotron light detector
  - magnetic chicane spectrometer ( T-474 )

Parameter	SLAC ESA	ILC-500
Repetition Rate	10 Hz	5 Hz
Energy	28.5 GeV	250 GeV
e <sup>-</sup> Polarization	(85%)	>80%
Train Length	up to 400 ns	1 ms
Microbunch spacing	20-400 ns	337 ns
Bunches per train	1 or 2	2820
Bunch Charge	$2.0 \times 10^{10}$	$2.0 \times 10^{10}$
Energy Spread	0.15%	0.1%

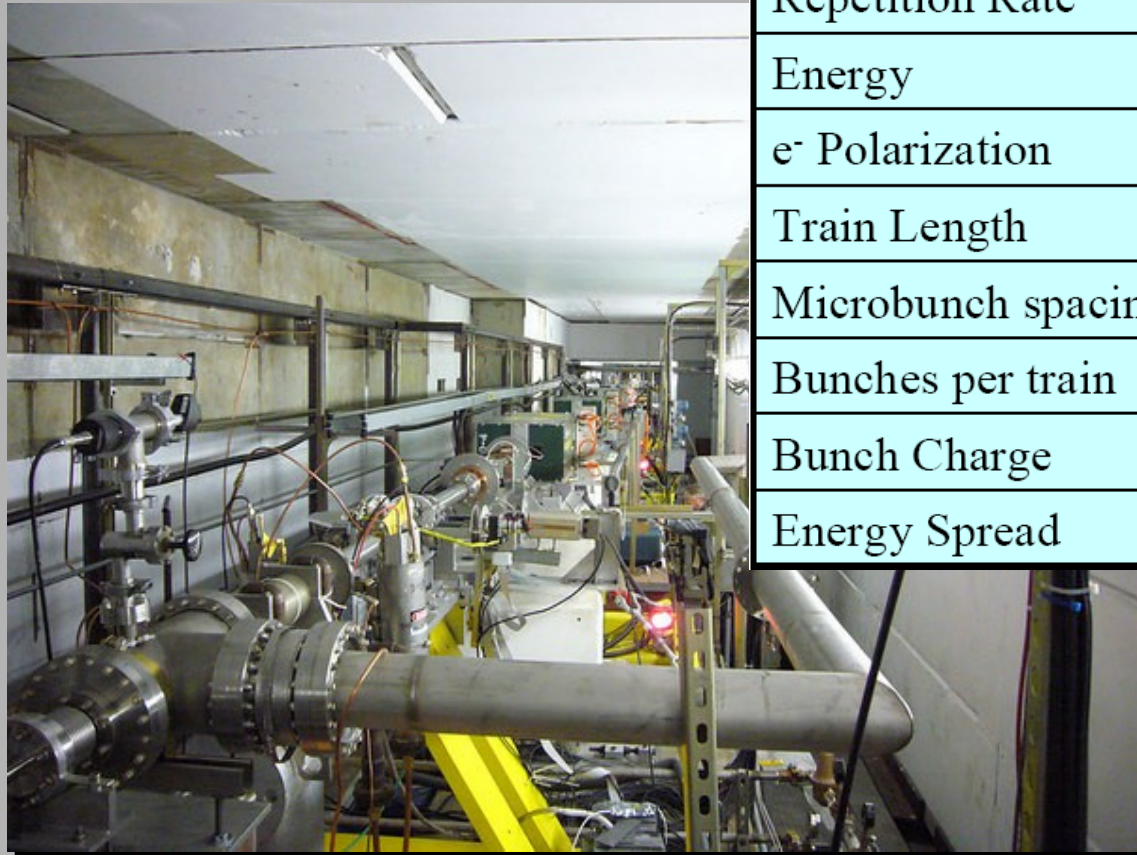

Possibility to vary energy, bunch charge  
bunch length etc.. systematic studies !



# T474 at ESA (SLAC)

Collaboration with LBNL (Y. Kolomensky et al.), SLAC (M. Woods et al.), Notre Dame (M. Hildreth et al.), DESY Zeuthen, JINR Dubna, ...

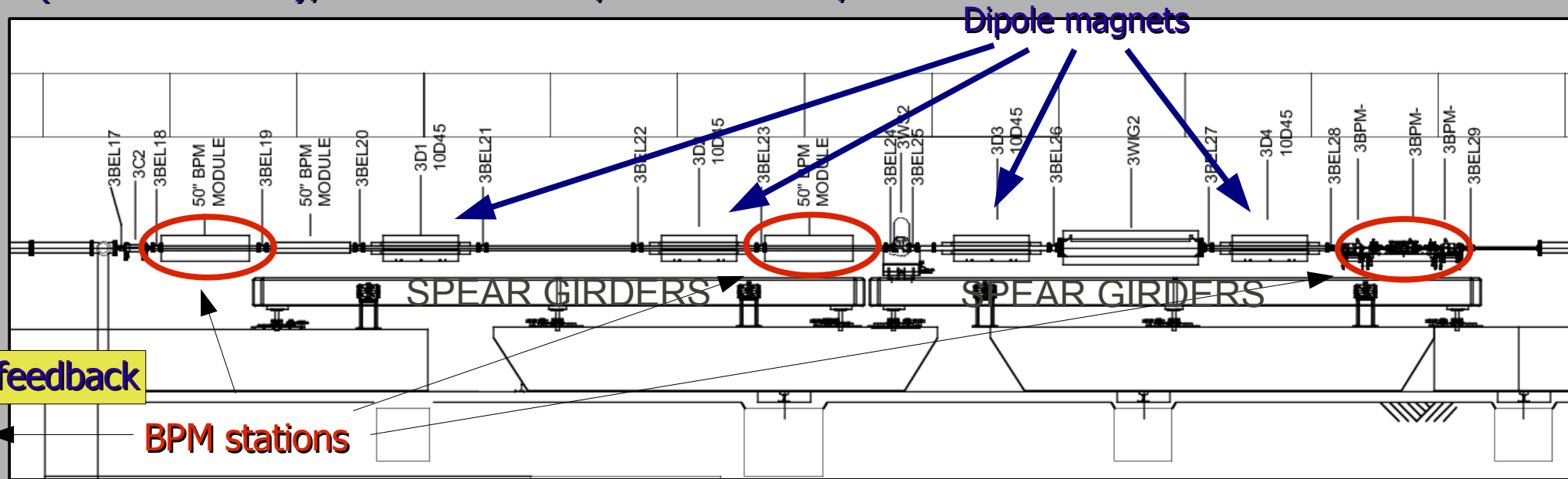

- April run 2006 ( 2 weeks ) :
  - Commissioning of new cold linac prototype triplet (BPM 3,4,5), where BPM4 on x,y mover system
  - Commissioning of old SLAC BPMs (9,10,11)
  - Digitisation/signal processing optimization
- July run 2006 ( 2 weeks ) :
  - Commissioning of interferometer system (BPMs 3,4,5) + energy BPM24 upstream
  - Stability data taking with 10 BPMs, frequent calibrations
- March 2007 ( 2 weeks ) :
  - Commissioning of calibration tone system and new UK BPM processor hardware
  - Commissioning of 4 chicane magnets and first full spectrometer data

# BPM Calibration at ESA...

- Calibrate the measured BPM position against a well known beam offset.
- Important to minimize impact for this on physics data taking...
- At ESA :
  - feedback setpoint calibrations : do we trust the setpoint calibration ?
  - corrector calibrations : feedback off, drifts !
  - mover calibrations : correct with interferometer, correction factor, however be careful for fake interferometer drifts !
  - helmholtz coil calibrations : fast, averaging slopes ( march 2007 run )
- Automation of the process is an important operational issue for the ILC

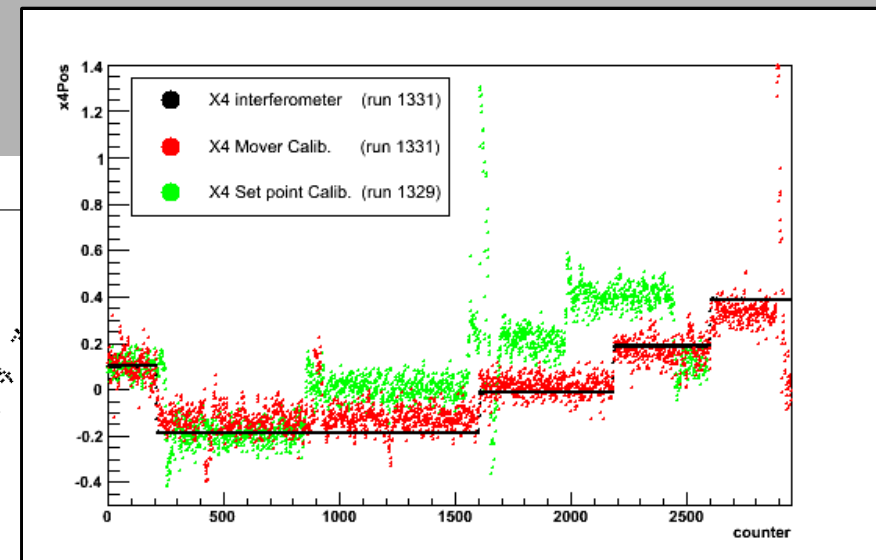
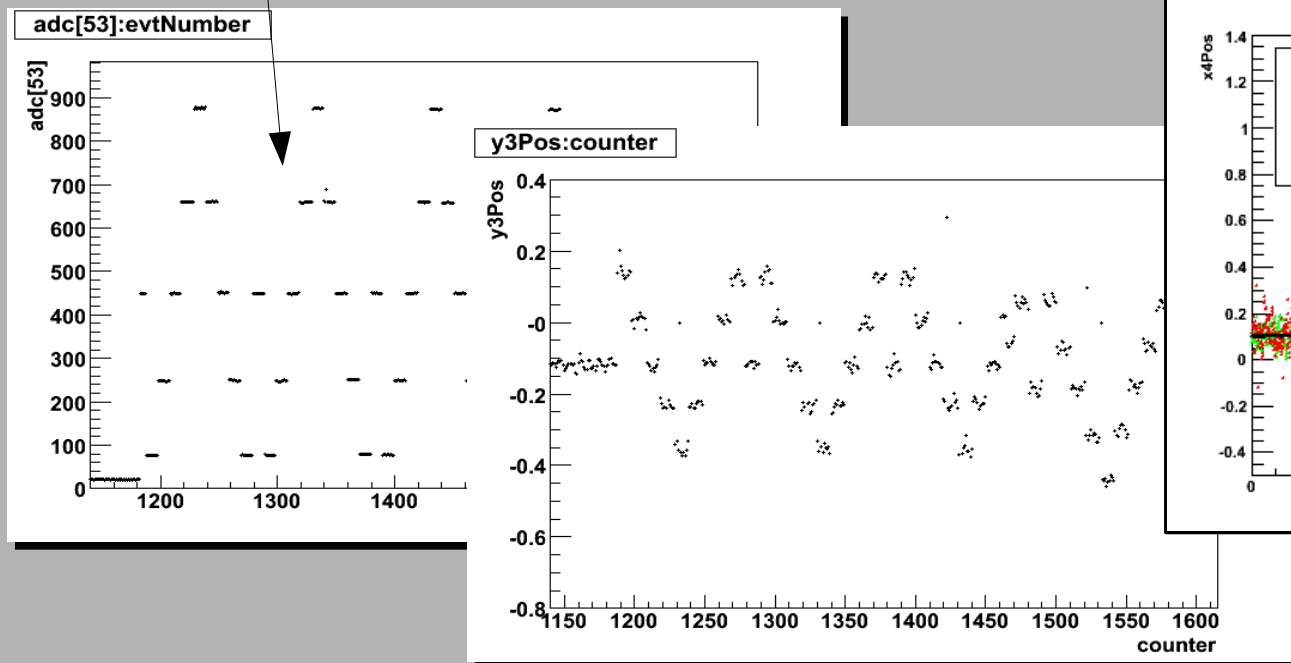

# Stability issues : degradation of resolution over time

First of all... let's define resolution :)

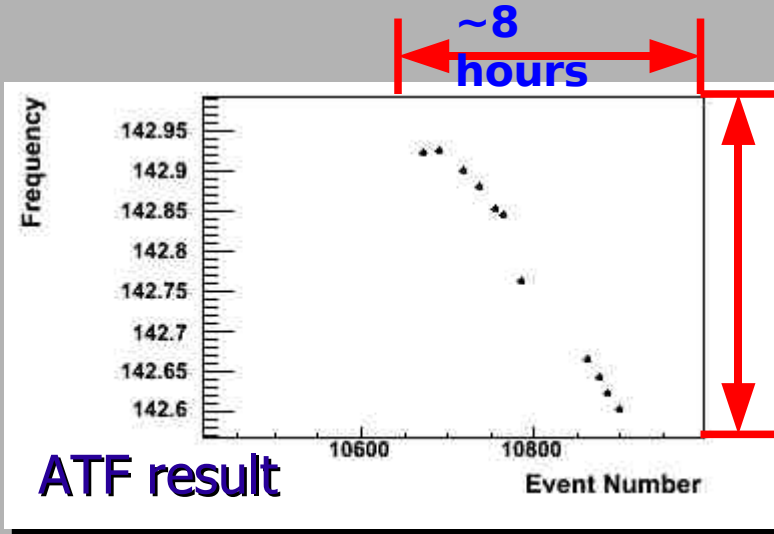

- Mainly temperature drifts cause degradation of the system
  - gain drifts
  - cavity shape changes : frequency changes
- Constant calibration tone !!

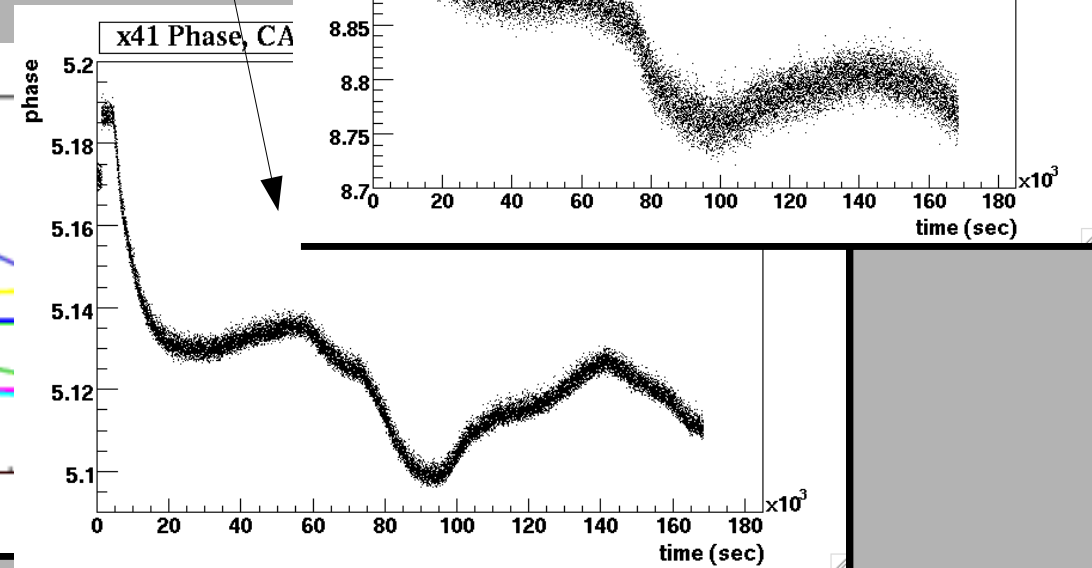
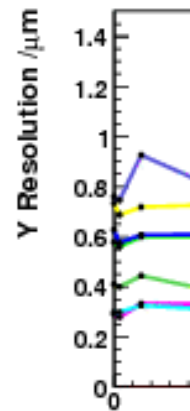
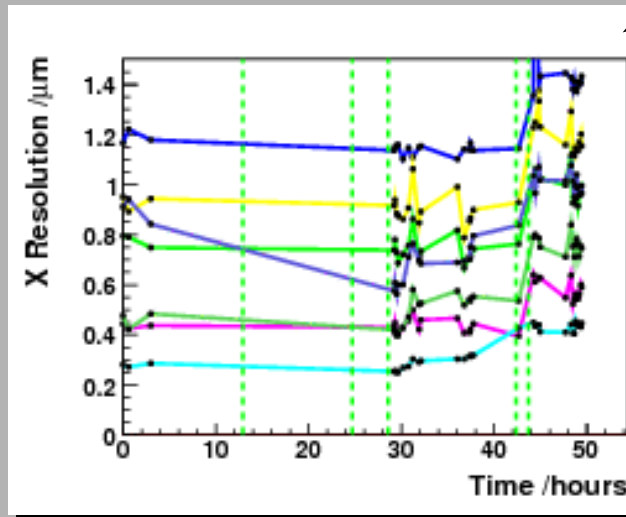

# Drift of residual means...

- Monitors the relative gain drifts between the stations in terms of position measurement
- Direct impact on the stability of the energy measurement

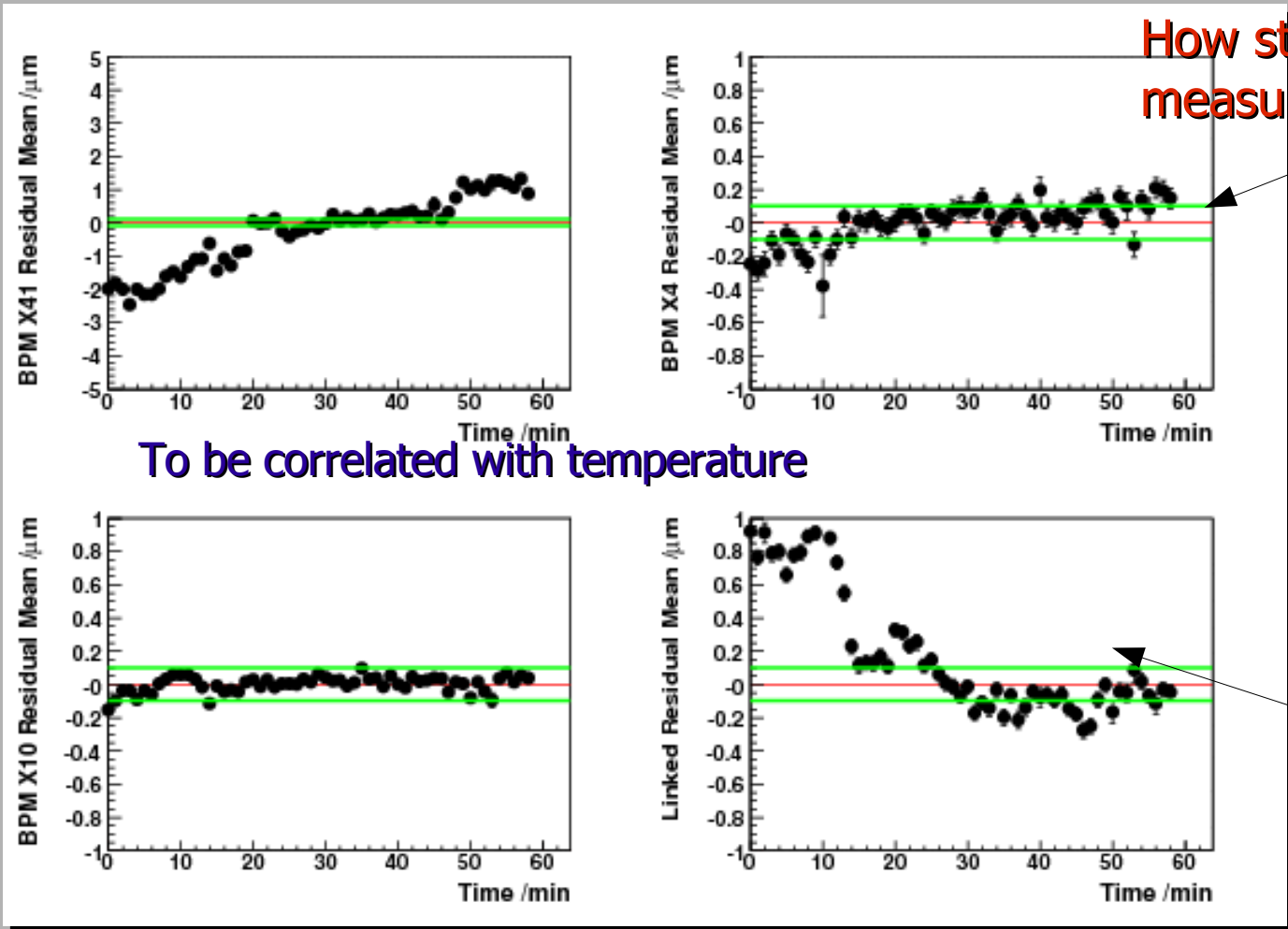

How stable is our position measurement in 1 BPM station

To be correlated with temperature

How stable is our measurement of the entire orbit ?

# Magnetic measurements...

- 4 Magnets were mapped during summer 206 in SLAC measurement lab (SLAC, DESY, JINR)
- Operating current of 150 A
- Integrated Bdl of 1.1 kG.m
- Long term stability analysis in progress

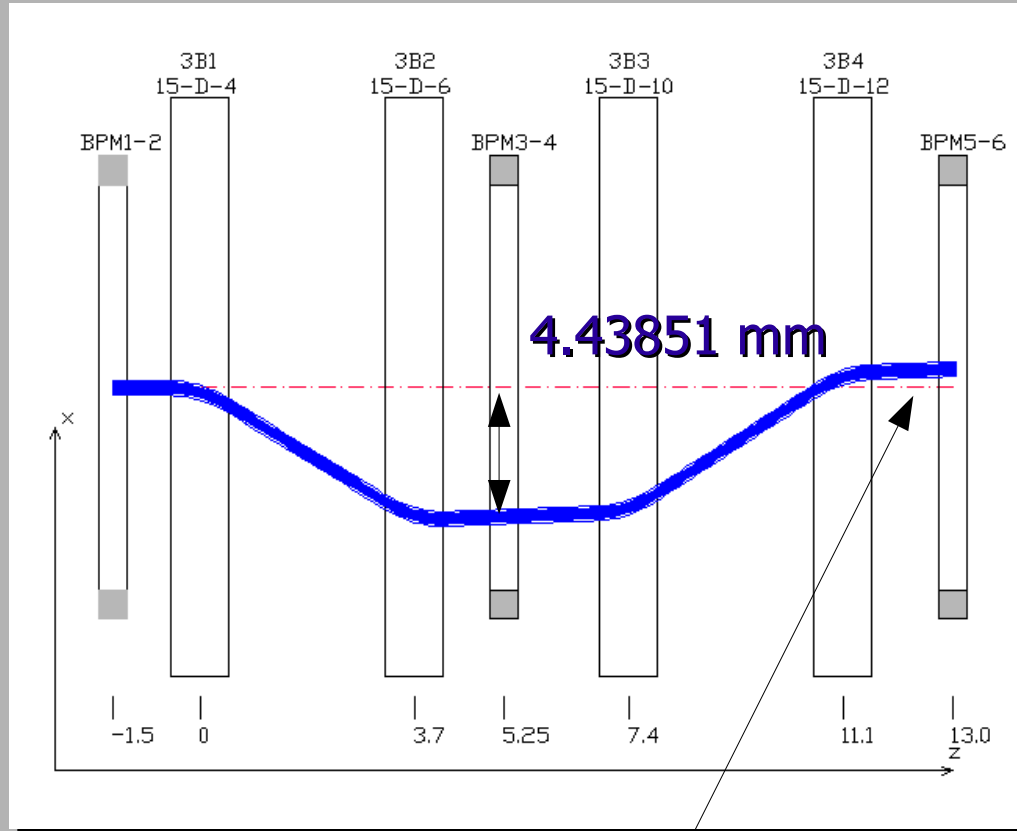
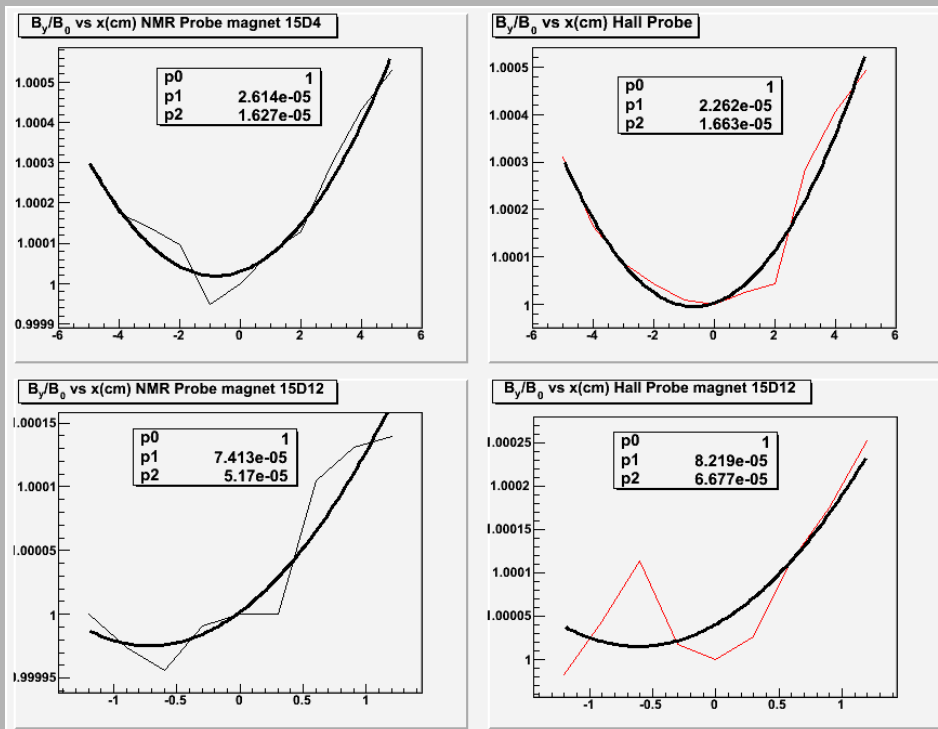

Small inhomogeneity in magnets

Important to understand for future ILC operation : beam disruption after chicane



# Chicane results, first beam energy measurements

- Taking into account integral B.dI and deflection at center of chicane, can compute correct beam energy
- Have to **subtract incoming orbit** in each event
- Total error in energy calculation  $2.5e-4$  (  $\sim 7$  MeV ) (preliminary!)
- Further detailed analysis stability studies underway...
- More and better data to come in July...

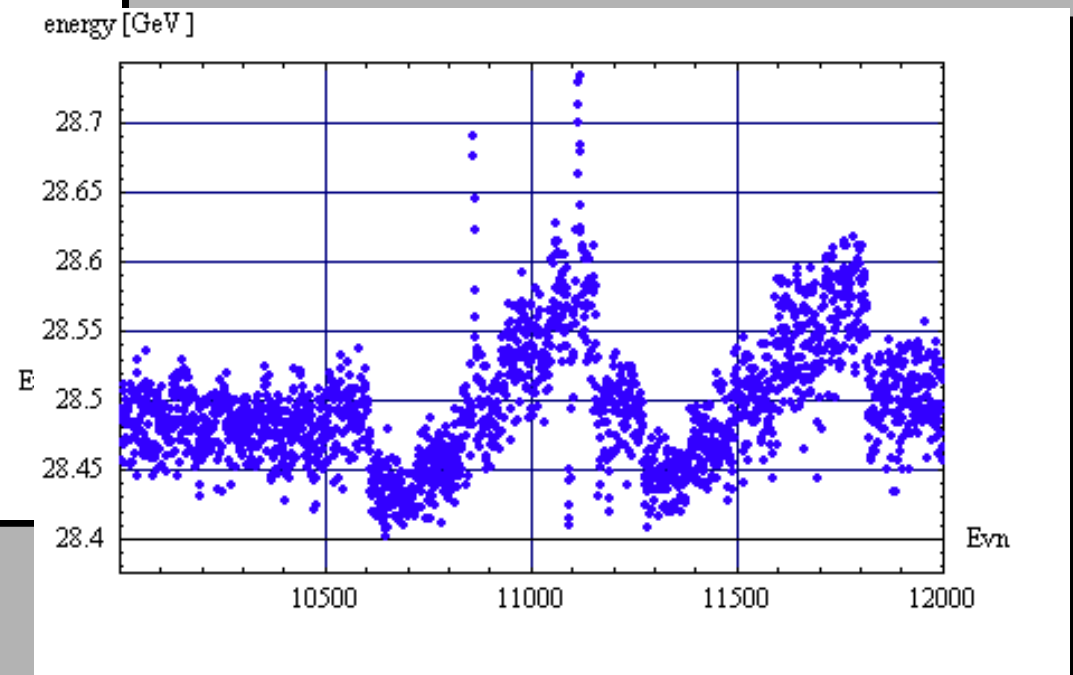
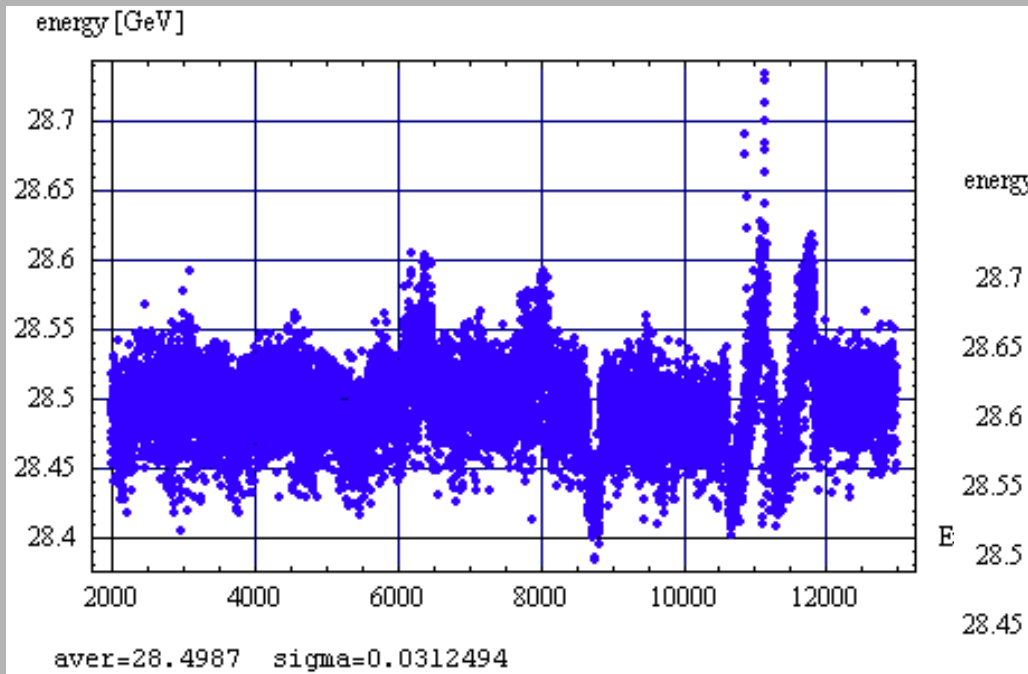

# Future plans for ESA

- Had 3 successful runs so far
- Upcoming run in July 9<sup>th</sup> until the 22<sup>th</sup> 2007.
- Install and commission the new spectrometer BPM prototype complete with mover system
  - cavities are currently being measured on UCL and RHUL testbenches
  - mover system is being commissioned
    - vertical elevation stage and horizontal stages with stepper motors and linear encoders ( 0.5 and 0.1  $\mu\text{m}$  resp )
    - Improve processor electronics in long run...
- Continue taking data with chicane, need to understand better systematics and stability
- Couple of papers underway : commissioning, Spectrometer BPM prototype and full T-474 ESA paper

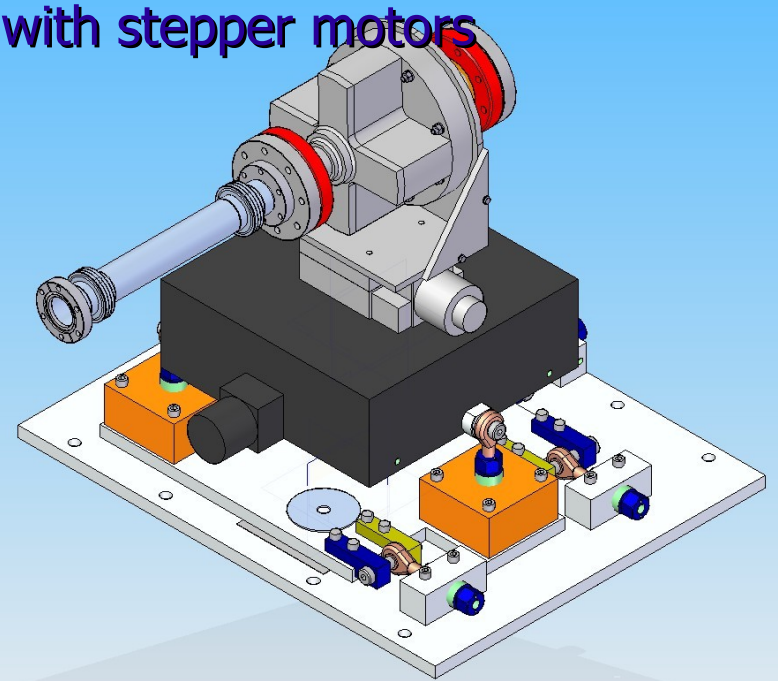

# Simulation....

Of course.. one final issue... It's all fine to study stability and operational issues at 28.5 GeV, but we really need it at **500 GeV** : simulation !

Currently developing :

- GEANT4 simulation of simple spectrometer chicane
  - beam distortion, track halo, synchrotron radiation
  - interface with core BPM processing library and simulation library to have a full simulation of the entire system
- **Transport beam down to IP** through rest of BDS
- **Make studies for optimal chicane design, update baseline document eventually**

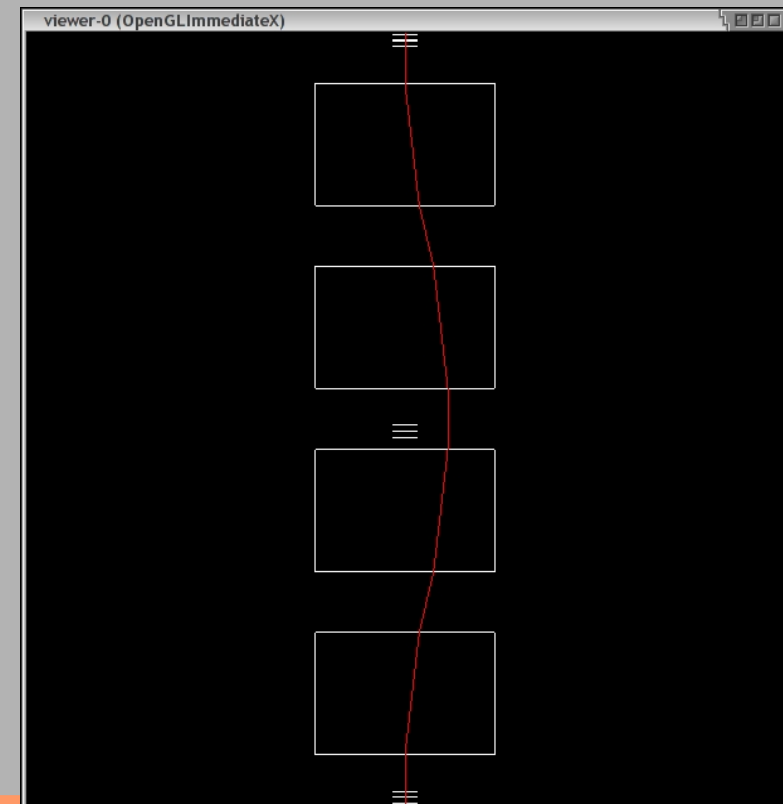
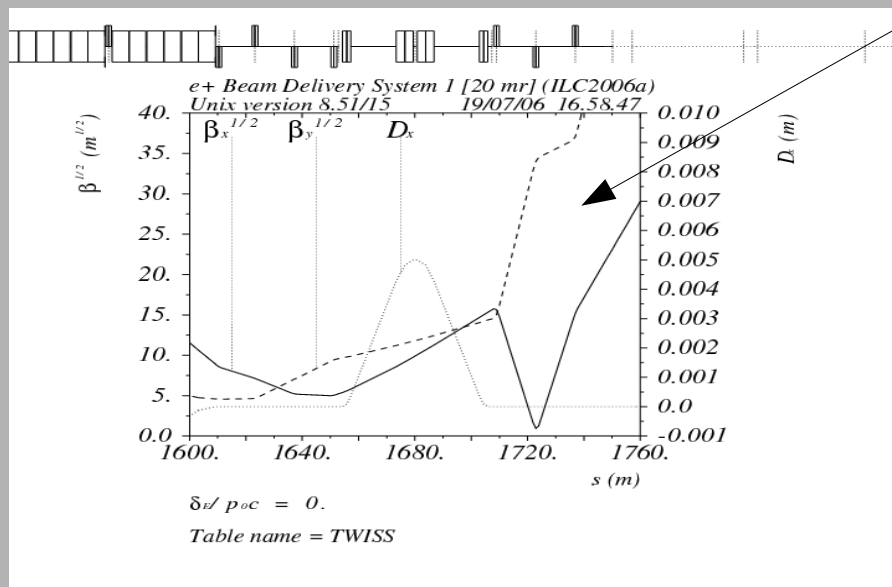

# Summary

- Physics case for an a 1 TeV linear e+e- collider is clear !
- Importance of the **energy measurement**, direct contribution to **systematics** on threshold studies ( e.g. Top quark )
- Proposed magnetic chicane for **single pass energy measurement**
- Based upon high resolution **resonant cavity beam position monitors**
- Operational principles of these devices
- Full chicane prototype test experiment is commissioned at **ESA in SLAC**
- First results, data analysis ongoing + next run planned for this summer...
- Simulation studies...

# Thanks for listening...

...and for the interested :

Some links at UCL

<http://www.hep.ucl.ac.uk/lc/>

<http://www.hep.ucl.ac.uk/~bino/T474/>

<http://www.hep.ucl.ac.uk/~liapine/>

<http://www.hep.ucl.ac.uk/~sboogert/>

SLAC ILC page

<http://www-project.slac.stanford.edu/ilc/default.htm>

SLAC ESA page

<http://www-project.slac.stanford.edu/ilc/testfac/ESA/esa.html>

Central ILC page

<http://www.linearcollider.org>

